

CITY OF LAFAYETTE

3675 Mt. Diablo Boulevard, Suite 210

(925) 284-1951

www.ci.lafayette.ca.us/gov



NOTICE TO CONTRACTORS BID PROPOSAL CONTRACT AGREEMENT CONTRACT SPECIAL PROVISIONS

FOR

2013 SURFACE SEAL PROJECT

City Project No. 014-9695

Bid Opening Date

Thursday, April 25, 2013, 2:00 p.m.

TABLE OF CONTENTS

	<u>Page No.</u>
NOTICE TO CONTRACTORS	N-1
BID PROPOSAL	P-1
BID SCHEDULE	P-2
NONCOLLUSION DECLARATION	P-5
PROPOSAL GUARANTEE “BID BOND” WITH NOTORIZED SHEETS	P-6
PROPOSAL SIGNATURE SHEET	P-7
CONTRACT AGREEMENT FOR CONSTRUCTION	C-1
PAYMENT BOND	C-4
PERFORMANCE BOND	C-5
SPECIAL PROVISIONS	
GENERAL	S1
SECTION SP 1 – TERMS, DEFINITIONS AND ABBREVIATIONS	S2
SECTION SP 2 – BID PROPOSAL REQUIREMENTS	S2
SECTION SP 3 – AWARD AND EXECUTION OF CONTRACT	S2
SECTION SP 4 – PLANS AND SPECIFICATIONS (GENERAL)	S3
SECTION SP 5 – CONTROL OF WORK AND MATERIALS	S4
SECTION SP 6 – LEGAL RELATIONS AND RESPONSIBILITIES	S8
SECTION SP 7 – EXISTING UTILITIES	S12
SECTION SP 8 – PROGRESS OF WORK	S13
SECTION SP 9 – MEASUREMENT AND PAYMENT	S15
SECTION SP 10– NOT USED	S15
SECTION SP 11—MISCELLANEOUS	S16
SECTION SP 12– MOBILIZATION	S17
SECTION SP 13– CONSTRUCTION AREA SIGNS	S25
SECTION SP 14– TRAFFIC CONTROL	S26
SECTION SP 15– DUST CONTROL	S30
SECTION SP 16– CLEARING & GRUBBING, TREE TRIMMING AND PROTECTION	S31
SECTION SP 17– EXISTING HIGHWAY FACILITIES	S33
SECTION SP 18– AGGREGATE BASE	S36
SECTION SP 19– PAVEMENT REPAIR AND SKIN PATCH	S37
SECTION SP 20– CRACK SEALING	S39
SECTION SP 21– SLURRY SEAL	S41

SECTION SP 22– MICRO-SURFACING	S48
SECTION SP 23– NOT USED.....	S55
SECTION SP 24– RUBBERIZED CHIP SEAL	S56
SECTION SP 25– CONCRETE CONSTRUCTION	S65
SECTION SP 26– TEMPORARY PAVEMENT DELINEATION	S67
SECTION SP 27– PAVEMENT STRIPING, MARKERS AND DELINEATION	S70
SECTION SP 28– VEHICLE DETECTION LOOPS	S73

APPENDIX A: STANDARD PLANS

APPENDIX B: WASTE MANAGEMENT PLAN AND WASTE ASSESSMENT FORM

APPENDIX C: STAGING AREA LOCATION AND LIMITS

APPENDIX D: PROJECT PLANS

APPENDIX E: RESIDENT NOTIFICATION LETTER

APPENDIX F: PROJECT NOTIFICATION SIGNS

NOTICE TO CONTRACTORS

Sealed proposals will be accepted at the office of the City Clerk, 3675 Mt. Diablo Boulevard, Suite 210, Lafayette, California until 2:00 P.M., Thursday, April 25th, 2013, at which time they will be publicly opened and read, for: Construction of **2013 Surface Seal Project, Project No. 014-9695**, including, but not limited to: mobilization; traffic control and construction signage; clearing and grubbing including tree trimming; traffic striping, marking and marker removal, removal and replacement of concrete curb, gutter, sidewalk, driveway; construction of asphalt concrete pavement repairs, crack seal, rubberized chip seal, slurry seal, micro-surfacing, traffic stripes, markers, and markings; and all other work as shown on the plans and as described in the specifications to provide a complete project.

The Engineer's cost estimate for is **\$580,000**.

Contract documents, including the plans and specifications, may be obtained at the City of Lafayette Engineering Services Division. The cost of bid documents is \$10 per set. The cost of mailing is an additional \$7. A link to electronic bid documents may be obtained free of charge by contacting the Engineering Department at (925)284-1951.

This project shall be constructed in accordance with the September 2002 edition of the City of Lafayette Standard Specifications, which may be obtained at the City of Lafayette Engineering Services Division. The cost of the Standard Specifications is \$15 per set. The cost of mailing is an additional \$7. If you already have the Standard Specifications (dated September 2002), you do not need to purchase a new copy.

Bids shall be submitted in a sealed envelope titled "**Proposal: 2013 Surface Seal Project, Project No. 014-9695**".

The Contractor shall possess a Class "A" license at the time this contract is awarded.

Bidder's attention is directed to requirements in Sections 2 and 3 of the Standard Specifications General Provisions.

All bids shall be accompanied by a cashier's or certified check, or a bidder's bond executed by a corporate surety insurer. The bidder's guarantee shall be in the amount equal to at least ten (10) percent of the total bid and shall be made payable to the City of Lafayette. The successful bidder shall furnish a payment bond and a performance bond.

The Owner reserves the right to waive any informalities or to reject any or all bids.

The City Council has ascertained the General Prevailing Rates of Wages applicable to this work, and these rates are on file in the office of the City of Lafayette Engineering Services Division.

Time of completion allowed for this project will be **Forty (40) working days**. Bidder's attention is directed to the schedule stated in Section SP-8 of the Special Provisions.

Questions regarding the project plans or specifications may be directed to Matt Luttropp, City Engineer's Office, (925) 299-3247.

The plan holders list, as well as the City Standard Specifications, the Project Special Provisions and the General Prevailing Rates of Wages applicable to this work may be downloaded free of charge from the City of Lafayette web page at <http://www.ci.lafayette.ca.us> (click on Capital Improvements under the Quick Links sidebar on the homepage). Or you may contact the Engineering Department at (925) 284-1951.

CITY OF LAFAYETTE

Date: 3/20/2012

By: /s/
Tony Coe, City Engineer

**CITY OF LAFAYETTE
CALIFORNIA
BID PROPOSAL
2013 SURFACE SEAL PROJECT
PROJECT NO. 014-9695**

TO THE CITY COUNCIL OF THE CITY OF LAFAYETTE:

In compliance with the annexed notice inviting sealed proposals, the undersigned bidder hereby proposes and agrees to perform the work therein described and to furnish all labor, materials and equipment necessary therefor, in accordance with the Plans and Specifications therefor, and further agrees to enter into a contract therefor, at the following prices:

<u>ITEM NO.</u>	<u>ITEM DESCRIPTION</u>	<u>ESTIMATED QUANTITY</u>	<u>UNIT</u>	<u>UNIT PRICE</u>	<u>TOTAL</u>
-----------------	-------------------------	---------------------------	-------------	-------------------	--------------

(SEE ATTACHED BID SCHEDULE)

- NOTES:
- All unit prices shall be considered the prices for providing a complete, in-place facility.
 - In the event of a discrepancy between the unit price and item total on the bid Schedule, the unit price shall be used.

o o o

Bidder acknowledges the receipt of the following addenda to the drawings and specifications.

<u>Addendum No.</u>	<u>Date</u>	<u>Addendum No.</u>	<u>Date</u>
_____	_____	_____	_____
_____	_____	_____	_____

o o o

**2013 SURFACE SEAL PROJECT
PROJECT NUMBER 014-9695**

BID SCHEDULE

BASE BID

ITEM NO.	ITEM DESCRIPTION	ESTIMATED QUANTITY	UNIT	UNIT PRICE	TOTAL
1	Mobilization (SP-12)	1	LS		
2	Project Identification and Information Signs (SP-12)	1	LS		
3	Construction Area Signs (SP-13)	1	LS		
4	Traffic Controll (SP-14)	1	LS		
5	Clearing and Grubbing, Tree Trimming, and Tree Protection (SP-16)	1	LS		
6	Remove and Replace Concrete Curb and Gutter (SP-25)	66	LF		
7	Remove and Repalce Concrete Driveway or Sidewalk (SP-25)	235	SF		
8	Install Traffic Signal Loop (SP-28)	6	EA		
9	Pavement Repair (6-Inch) (SP-19)	17631	SF		
10	Skin Patch (SP-19)	9350	SF		
11	Crack Seal (SP-20)	1	LS		
12	Slurry Seal (SP-21)	58470	SY		
13	Rubberized Chip Seal (SP-24)	45250	SY		
14	Remove Existing Pavement Markers and Thermoplastic Stripes and Legends (SP-17)	1	LS		
15	Temporary Pavement Delineation (SP-26)	1	LS		
16	Install Thermoplastic Legends and Markings (SP-27)	1448	SF		
17	Install 4" Thermoplastic Stripe (White or Yellow) (SP-27)	2082	LF		
18	Install 12" Thermoplastic Stripe (White or Yellow) (SP-27)	1668	LF		
19	Install Detail 4 (Single Yellow Bots Dots with Reflectors) (SP-27)	1380	LF		
20	Install Detail 23 (Double Yellow Centerline) (SP-27)	8415	LF		
21	Install Detail 27B (4" Thermoplastic White Stripe) (SP-27)	2800	LF		
22	Install Detail 38 (8" Channelizing Thermoplastic Stripe with Reflectors) (SP-27)	147	LF		
23	Install Two-Way Reflective Pavement Markers (Blue) (SP-27)	8	EA		
24	Paint Curb Red (SP-27)	170	LF		
	TOTAL				

(F) Denotes Final Pay Quantity per Section 9-1.015 of the State Specifications

BID ALTERNATE ITEMS

ITEM NO.	ITEM DESCRIPTION	ESTIMATED QUANTITY	UNIT	UNIT PRICE	TOTAL
12A	Type II Micro-Surfacing (SP-22)	58470	SY		

(F) Denotes Final Pay Quantity per Section 9-1.015 of the State Specifications

Contract Proposal

Attention Bidders:

Bidders shall complete both the "Base Bid" and "Alternate Bid" in order to submit a responsive bid. The contract will be awarded on the basis of the lowest responsible bid for the Base Bid. The City will determine and reserves the right and discretion after the Bid Opening whether to include Alternate Bid item(s) per bid prices submitted by the contractor selected. The contractor shall honor said bid prices. The contractor will be advised of the addition at the pre-construction meeting.

Bidder agrees that in case of default in executing and returning the required contract and bonds within ten (10) calendar days after having received the contract, proceeds of the guarantee accompanying his bid will become the property of the City of Lafayette.

o o o

In conformance with Subsection 2-13 "Listing of Proposed Subcontractors" of the Standard Specifications, the name and location of the place of business of each subcontractor is as follows:

	<u>NAME</u>	<u>ADDRESS</u>	<u>WORK TO BE PERFORMED</u>
1.	_____	_____	_____
2.	_____	_____	_____
3.	_____	_____	_____
4.	_____	_____	_____
5.	_____	_____	_____

o o o

Bidder certifies that he is licensed in accordance with an act providing for the registration of Contractors as follows:

License No. _____ Class _____

o o o

Bidder certifies that he has not, nor have any of his or its agents, officers, representatives, or employees, been guilty of collusion with any officer or representative of the City of Lafayette or with any other party or parties in the submission of this Proposal; nor has said bidder received any preferential treatment by any officer or employee of the City of Lafayette in the matter of making or submitting this proposal. The undersigned declares under penalty of perjury that the foregoing is true and correct.

o o o

Bidder certifies that there will be no discrimination in employment with regard to race, color, religion, sex, sexual orientation, or national origin; that all Federal, State, and local directives and executive orders regarding nondiscrimination in employment will be complied with and that the principle of equal opportunity

Contract Proposal

in employment will be demonstrated positively and aggressively.

All bidders that have not had a contract with the City of Lafayette during the past three (3) years shall list below previous jobs that they have successfully completed and shall also show the amount of the contract therefor.

Name and Address of Agency or Individual for Whom Work was Done	Phone Number	Date Completed	Contract Price
1.			
2.			
3.			
4.			
5.			
6.			

NONCOLLUSION DECLARATION

The undersigned declares:

I am the _____ of _____, the party making the foregoing bid.
Title Firm

The bid is not made in the interest of, or on behalf of, any undisclosed person, partnership, company, association, organization, or corporation. The bid is genuine and not collusive or sham. The bidder has not directly or indirectly induced or solicited any other bidder to put in a false or sham bid. The bidder has not directly or indirectly colluded, conspired, connived, or agreed with any bidder or anyone else to put in a sham bid, or to refrain from bidding. The bidder has not in any manner, directly or indirectly, sought by agreement, communication, or conference with anyone to fix the bid price of the bidder or any other bidder, or to fix any overhead, profit, or cost element of the bid price, or of that of any other bidder. All statements contained in the bid are true. The bidder has not, directly or indirectly, submitted his or her bid price or any breakdown thereof, or the contents thereof, or divulged information or data relative thereto, to any corporation, partnership, company association, organization, bid depository, or to any member or agent thereof to effectuate a collusive or sham bid, and has not paid, and will not pay, any person or entity for such purpose.

Any person executing this declaration on behalf of a bidder that is a corporation, partnership, joint venture, limited liability company, limited liability partnership, or any other entity, hereby represents that he or she has full power to execute, and does execute, this declaration on behalf of the bidder.

I declare under penalty of perjury under the laws of the State of California that the foregoing is true and correct and that this declaration is executed on _____, at
Date

_____, _____.
City State

By: _____
Signature

Name: _____
Printed or Typed

Date: _____

Title: _____

PROPOSAL GUARANTEE

BID BOND

**2013 SURFACE SEAL PROJECT
PROJECT NO. 014-9695**

KNOW ALL PERSONS BY THESE PRESENTS that _____, as BIDDER, and _____, as SURETY, are held and firmly bound unto City of Lafayette, as Owner, in the penal sum of _____ dollars (\$) which is ten percent of the total amount bid by BIDDER to Owner for the above stated project, for the payment of which sum, BIDDER and SURETY agree to be bound, jointly and severally, firmly by these presents.

THE CONDITIONS OF THIS OBLIGATION ARE SUCH that, whereas BIDDER is about to submit a bid to Owner for the above stated project, if said bid is rejected, or if said bid is accepted and a contract is awarded and entered into by BIDDER in the manner and time specified, then this obligation shall be null and void, otherwise it shall remain in full force and effect in favor of Owner.

IN WITNESS WHEREOF the parties hereto have set their names, titles, hands, and seals this ____ day of _____, 2013.

BIDDER _____

SURETY _____

Subscribed and sworn to this ____ day of _____, 2013.

NOTARY PUBLIC _____

PROPOSAL SIGNATURE SHEET

The completed proposal submitted herewith includes all sheets numbered "P-1 through P-7" at the bottom. The following required attachments have been executed and are included:

- a. Bid Proposal (with Addenda acknowledgement)
- b. Bid Schedule
- c. Noncollusion Declaration
- d. Proposal Guarantee "Bid Bond" with Notarized Signatures
- e. Proposal Signature Sheet

Legal Name of Firm: _____

Business Address: _____

Telephone Number: () _____

Type of Organization: () Individual () Partnership () Corporation

Joint Venture Proposal?: () Yes () No

Authorized Signature: _____

Name: _____

Position: _____

Date of Execution: _____

For a partnership, name all co-partners below,
For a corporation, name president, secretary, treasurer and manager.

NAME	TITLE
_____	_____
_____	_____
_____	_____
_____	_____

Corporate Seal:

CITY OF LAFAYETTE
CONTRACT AGREEMENT
FOR
CONSTRUCTION

THIS AGREEMENT is made and entered into as of _____, 2013, by and between the CITY OF LAFAYETTE ("City") and _____ ("Contractor").

RECITALS

- A. City desires to retain the services of Contractor to provide services for Construction of **2013 Surface Seal Project, Project No. 014-9695**, including, but not limited to: mobilization; traffic control and construction signage; clearing and grubbing including tree trimming; traffic striping, marking and marker removal, removal and replacement of concrete curb, gutter, sidewalk, and driveway; construction of asphalt concrete pavement repairs, crack seal, rubberized chip seal, slurry seal, micro-surfacing, traffic stripes, markers, and markings; and all other work as shown on the plans and as described in the specifications to provide a complete project.
- B. Contractor has represented to City that it has the expertise, experience and qualifications to perform the services described in Paragraph A, above, and those services which are more fully described below.

NOW, THEREFORE, in consideration of the foregoing and the covenants and agreements set forth below, City and Contractor agree as follow:

- 1. Contract Documents. The contract documents for the aforesaid project shall consist of the Notice to Contractors, Bid Proposal, General Provisions, Technical Provisions, Special Provisions including appendices, Design Drawings, and all referenced specifications, details, standard drawings, and their appendices; together with this Contract Agreement and all required bonds, insurance certificates, permits, notices and affidavits; and also including any and all addenda or supplemental agreements clarifying, amending, or extending the work contemplated as may be required to insure its completion in an acceptable manner. All of the provisions of said contract documents are made a part hereof as though fully set forth herein.
- 2. Services. For and in consideration of the payments and agreements to be made and performed by City, Contractor agrees to furnish all materials and perform all work required for the above-stated project, and to fulfill all other obligations as set forth in the aforesaid contract documents. Contractor agrees to receive and accept the prices set forth in the Proposal as full compensation for furnishing all materials, performing all work, and fulfilling all obligations hereunder. Said compensation shall cover all expenses, losses, damages, and consequences arising out of the nature of the work during its progress or prior to its acceptance including those for well and faithfully completing the work and the whole thereof in the manner and time specified in the aforesaid contract documents; also including those arising from actions of the elements, unforeseen difficulties or obstructions encountered in the prosecution of the work, suspension or discontinuance of the work, and all other unknowns or risks of any description connected with the work.
- 3. Employment by City. City hereby promises and agrees to employ, and does hereby employ, Contractor to provide the materials, do the work, and fulfill the obligations according to the terms and conditions herein contained and referred to, for the prices aforesaid, and hereby contracts to pay the same at the time, in the manner, and upon the conditions set forth in the contract documents.

Contract Agreement

13. Claims Procedure. In the event of a dispute between the parties regarding a) a time extension demand, b) payment arising for work performed by or on behalf of the contractor which is not otherwise expressly provided for, or c) an amount the payment of which is disputed by the City, the procedure in Section 10 of the City of Lafayette Standard Specifications shall be used.

IN WITNESS WHEREOF the parties hereto for themselves, their heirs, executors, administrators, successors, and assigns do hereby agree to the full performance of the covenants herein contained and have caused this Contract Agreement to be executed in duplicate by setting hereunto their names, titles, hands, and seals this ____ day of _____ 2013.

Contractor: _____
<Type Business Name Here>

Name: _____

Title: _____

Contractor's License No. _____

Agency Business License No. _____

Federal Tax Identification No. _____

Subscribed and sworn to this ____ day of _____ 2013.

Notary Public _____

Agency: _____
City Manager of the City of Lafayette

Attested: _____
City Clerk of the City of Lafayette

Date: _____

PAYMENT BOND

(TO BE EXECUTED WITHIN TEN [10] CALENDAR DAYS OF CONTRACT AWARD)

WHEREAS, the City of Lafayette (Owner) has awarded to _____, as Contractor, a contract for the work described as follows: Construction of **2013 Surface Seal Project, Project No. 014-9695**, including, but not limited to: mobilization; traffic control and construction signage; clearing and grubbing including tree trimming; traffic striping, marking and marker removal, removal and replacement of concrete curb, gutter, sidewalk, and driveway; construction of asphalt concrete pavement repairs, crack seal, rubberized chip seal, slurry seal, micro-surfacing, traffic stripes, markers, and markings; and all other work as shown on the plans and as described in the specifications to provide a complete project.

AND WHEREAS, said Contractor is required to furnish a bond in connection with said contract, to secure the payment of claims of laborers, mechanics, materials persons, and other persons as provided by law;

NOW, THEREFORE, we, the undersigned Contractor and surety, are held firmly bound unto the Owner in the sum of _____ Dollars (\$_____), for which payment well and truly to be made we bind ourselves, our heirs, executors and administrators, successors and assigns, jointly and severally, firmly by these presents.

THE CONDITION OF THIS OBLIGATION IS SUCH:

That if said Contractor, its heirs, executors, administrators, successors, or assigns, or subcontractors, shall fail to pay any of the persons named in Civil Code Section 3282, or amounts due under the Unemployment Insurance Code with respect to work or labor performed by any such claimant, or any amounts required to be deducted, withheld, and paid over to the Employment Development Department from the wages of employees of the Contractor and its subcontractors pursuant to Section 13020 of the Unemployment Insurance Code, with respect to such work and labor, that the surety or sureties herein will pay for the same in any amount not exceeding the sum specified in this bond, otherwise the above obligation shall be void. In case suit is brought upon this bond, the said surety will pay a reasonable attorney's fee to the Owner in an amount to be fixed by the court.

This bond shall insure to the benefit of any of the persons named in Civil Code Section 3181 as to give a right of action to such persons or their assigns in any suit brought upon this bond.

IN WITNESS WHEREOF, we have hereunto set our hands and seals on this ____ day of _____, 2013.

CONTRACTOR: _____	SURETY _____
Print Name: _____	NAME _____
Title: _____	ADDRESS _____
	TELEPHONE _____

PERFORMANCE BOND

(TO BE EXECUTED WITHIN TEN [10] CALENDAR DAYS OF CONTRACT AWARD)

KNOW ALL PERSONS BY THESE PRESENTS:

THAT WHEREAS, the City of Lafayette (Owner) has awarded to _____, as Contractor, a contract for the work described as follows: Construction of **2013 Surface Seal Project, Project No. 014-9695**, including, but not limited to: mobilization; traffic control and construction signage; clearing and grubbing including tree trimming; traffic striping, marking and marker removal, removal and replacement of concrete curb, gutter, sidewalk, and driveway; construction of asphalt concrete pavement repairs, crack seal, rubberized chip seal, slurry seal, micro-surfacing, traffic stripes, markers, and markings; and all other work as shown on the plans and as described in the specifications to provide a complete project.

AS WHEREAS, the Contractor is required to furnish a bond in connection with said contract guaranteeing the faithful performance thereof;

NOW, THEREFORE, we, the undersigned Contractor and surety, are held firmly bound unto the Owner in the sum of _____ Dollars (\$_____), to be paid to the Owner, its successors and assigns, for which payment well and truly to be made we bind ourselves, our heirs, executors and administrators, successors and assigns, jointly and severally, firmly by these presents.

THE CONDITION OF THIS OBLIGATION IS SUCH:

That if said Contractor, its heirs, executors, administrators, successors, or assigns, shall in all things stand to and abide by and well and truly keep and perform the covenants, conditions, and agreements in the foregoing contract and any alteration thereof made as therein provided on its or their part to be kept and performed at the time and in the manner therein specified and in all respects according to their true intent and meaning, and shall indemnify and save harmless the Owner, its officers, and agents, as therein stipulated, then this obligation shall become and be null and void; otherwise it shall be and remain in full force and effect. In case suit is brought upon this bond, the said surety will pay a reasonable attorney's fee to the Owner in an amount to be fixed by the court. Surety, for value received, hereby stipulates and agrees that no amendment, change, extension of time, alteration, or addition to said contract, and of any feature or item or items of performance required therein or thereunder, shall in any manner affect its obligations on or under this bond; and said surety does hereby waive notice of any such amendment, change, extension of time, alteration, or addition to said contract, and of any feature or item or items of performance required therein or thereunder, shall in any manner affect its obligations on or under this bond; and said surety does hereby waive notice of any such amendment, change extension of time, alteration, or addition to said contract, and of any feature or item or items of performance required therein or thereunder.

IN WITNESS WHEREOF, we have hereunto set our hands and seals on this ____ day of _____, 2013.

CONTRACTOR: _____	SURETY _____
Print Name: _____	NAME _____
Title: _____	ADDRESS _____
	TELEPHONE _____

**CITY OF LAFAYETTE
SPECIAL PROVISIONS**

GENERAL

The work to be done under this contract, except as modified or supplemented herein, shall conform to the following:

- The City of Lafayette General Provisions of the Standard Specifications dated September 2002, herein referred to as the “General Provisions of the Standard Specifications”.
- The City of Lafayette Technical Provisions of the Standard Specifications dated September 2002, herein referred to as the “Technical Provisions of the Standard Specifications”.

Where specifically referred to, the work shall also conform to the following:

- The State of California Department of Transportation (Caltrans) Standard Specifications, For Construction of Local Streets and Roads, dated May 2006, herein referred to as the “State Specifications” or “State Standard Specifications”.
- The State of California Department of Transportation (Caltrans) Standard Plans, dated May 2006, herein referred to as the “State Standard Plans”.
- The Contra Costa County Public Works Department Standard Plans, most current edition, herein referred to as the “County Standard Plans”.

These Special Provisions are additions, modifications, or clarifications to the City of Lafayette Standard Specifications and supersede all sections of the Standard Specifications.

Refer to Section 5-4, “Precedence of Contract Documents”, of the General Provisions of the Standard Specifications for the order of precedence of contract documents.

SPECIAL PROVISIONS SECTION SP-1

TERMS, DEFINITIONS AND ABBREVIATIONS

(NO BID ITEM)

The provisions of Section 1, “Terms, Definitions and Abbreviations”, of the General Provisions of the Standard Specifications, shall apply in their entirety.

SPECIAL PROVISIONS SECTION SP-2

BID PROPOSAL REQUIREMENTS

(NO BID ITEM)

The provisions of Section 2, “Bid Proposal Requirements”, of the General Provisions of the Standard Specifications shall apply in their entirety.

SPECIAL PROVISIONS SECTION SP-3

AWARD AND EXECUTION OF CONTRACT

(NO BID ITEM)

The provisions of Section 3, “Award and Execution of Contract”, of the General Provisions of the Standard Specifications shall apply in their entirety and as supplemented herein.

SP3-01 PAYMENT

Full compensation for furnishing “Performance, Labor, and Materials Bonds” shall be considered as included in the lump sum price paid for “Mobilization” and no additional compensation shall be allowed therefore, even if the final contract price is increased up to 25% of the original base bid price.

SPECIAL PROVISIONS SECTION SP-4

PLANS AND SPECIFICATIONS (GENERAL)

(NO BID ITEM)

The provisions of Section 4, "Plans and Specifications (General)", of the General Provisions of the Standard Specifications shall apply in their entirety and as supplemented herein.

SP4-01 SCOPE OF WORK

The work to be performed under this contract including, but not limited to: mobilization; traffic control and construction signage; clearing and grubbing including tree trimming; traffic striping, marking, and markers removal, removal and replacement of concrete curb and gutter; construction of asphalt concrete pavement repairs, crack seal, rubberized chip seal, slurry seal, micro-surfacing, traffic stripes, markers, and markings; and all other work as shown on the plans and as described in the specifications to provide a complete project.

SP4-02 AS-BUILT PLANS

The City may retain a portion of the final retention until such time that the Contractor provides a complete set of As-Built Plans.

SP4-03 PAYMENT

No separate payment will be made for preparing and submitting "As-Built Drawings". Full compensation for preparing and submitting "As-Built Drawings" shall be considered as included in the prices paid for various contract items of work, and no additional compensation shall be allowed therefor.

SPECIAL PROVISIONS SECTION SP-5

CONTROL OF WORK AND MATERIALS
(NO BID ITEM)

The provisions of Section 5, "Control of Work and Materials", of the General Provisions of the Standard Specifications shall apply in their entirety and as supplemented herein.

SP5-01 CONSTRUCTION SURVEY STAKING

The Engineer will provide paint markings for pavement repair and skin patch limits.

SP5-02 MATERIAL SAMPLING AND TESTING

Compaction tests and/or material sampling and testing may be performed by the City's representatives on asphalt concrete, chip, slurry, and micro-surfacing materials and other work and materials which in the opinion of the Engineer require sampling or testing. Test locations shall be determined by the Engineer. The Contractor shall coordinate and cooperate with the Engineer and testing personnel and no claims of delays or inconvenience due to testing and/or sampling shall be allowed.

Testing is not a duty of the City and is solely at the discretion of the Engineer. Testing or non-testing by the City does not release the Contractor from his/her responsibility to perform all work in conformance with the Plans, Standard Specifications, and these Special Provisions.

If a test shows that the work in questions fails to meet the project specifications, retests shall be taken after the Contractor takes corrective measures. Retests shall be performed until a passing test is obtained. All costs that the City incurs for retesting shall be deducted from the payment due the Contractor.

The Engineer shall be given at least twenty-four (24) hours advance notice for any testing requested by the Contractor.

SP5-03 SUBMITTALS

The Contractor shall provide all submittals required by the Standard Specifications and these Special Provisions at the preconstruction meeting and prior to commencing any work.

Any work shown on the Plans to be installed per manufacturer's specifications or directions shall require a submittal. All materials specified by manufacturer name, code, model number, etc. and their approved equals shall require a Submittal.

The Contractor shall submit the number of copies which the Contractor requires, plus one (1) copy which will be retained by the Engineer. Mark each copy to identify the applicable products, models, options, and any other data. Submit the product source, specifications, gradations, certifications, bulletins and literature in sufficient detail to demonstrate that the product is in compliance with the Contract.

Special Provisions

At minimum, the Contractor shall provide the following submittals to the Engineer. Submittals shall be made in advance of the materials planned incorporation into the work, and shall allow the Engineer a minimum of five (5) working days to review the submittal and respond to the Contractor. No material shall be used in the work until written acceptance of the submittal has been made by the Engineer. The Contractor shall submit sufficient information, specifications, and product data to demonstrate compliance with the requirements of the Contract, including these Special Provisions, for:

- Chip seal, slurry seal and micro-surfacing mix designs and certification of compliance
- Rubberized chip seal, slurry seal and micro-surfacing aggregate
- Slurry seal and micro-surfacing asphalt emulsion
- Rubberized chip seal asphalt binder
- Equipment calibration documentation for chip, slurry and micro-surfacing equipment
- Asphalt concrete mix design
- Crack sealant material
- Traffic paint and glass beads
- Thermoplastic material
- Pavement markers
- Water pollution control plan
- Waste management plan
- Traffic control plan and certification of qualified personnel
- Project schedule

SP5-04 ORDER OF WORK

Unless otherwise directed by the Engineer, the following major items of work shall be performed in the following order.

- 1) Notify Underground Service Alert (USA) to have utilities marked
- 2) Install construction area signs and project identification signs
- 3) Install water pollution control measures
- 4) Install tree protection
- 5) Submit waste management plan prior to commencing any demolition work
- 6) Clearing, grubbing, tree trimming
- 7) Perform pavement repairs
- 8) Remove existing pavement markers, markings, and striping

Special Provisions

- 9) Perform crack sealing
- 10) Install chip seal
- 11) Install slurry seal or micro-surfacing
- 12) Place permanent striping, markers and legends
- 13) Complete all other construction work and punch list items
- 14) Remove tree protection, construction area signs and project identification signs
- 15) Submit completed waste assessment summary report form

The Contractor's attention is directed to Section SP-8-02, "Progress Schedule", of these Special Provisions.

Any deviation from these requirements and provisions shall be sufficient cause for the Engineer to suspend the work in accordance with the provisions of Section 8-3 of the General Provisions. The contractor will not be permitted to resume the work until Contractor has satisfactorily remedied said deviation in accordance with the provisions of the contract.

SP5-05 SUPERVISION

Section 5-8 "Superintendence" of the General Provisions is superseded by the following:

Unless otherwise explicitly directed and authorized by the Engineer, at all times during the progress of the work the Contractor shall have a project representative present at the construction site who shall have complete authority to represent and to act for the Contractor. **The project representative may not be a subcontractor or an employee of the subcontractor.**

Before initial work is begun on the Contract, the Contractor shall file with the Engineer, address and telephone numbers where the project representative can be reached during all hours, including nights and weekends, when the work is not in progress. The Contractor's project representative shall: Supervise the work crews and subcontractors; coordinate all construction activities and operations including but not limited to traffic control; progress payment, change orders, work by others (including utility companies) and public notifications. Lack of supervision shall be cause to suspend the work as provided for in Section 8-3 of the General Provisions.

When supervision is not provided as required, the Engineer has the discretion to allow work to proceed in the interest of progress of work. In that case the City may assess the Contractor for the lack of such supervision. The assessment shall be based on the current City of Lafayette hourly billing rate for engineering staff of \$125 per hour, plus a twenty (20) percent administrative markup multiplied the number of hours such superintendence has not been provided. The assessment shall be deducted from any amounts due to the Contractor.

SP5-06 REUSE AND RECYCLING REQUIREMENTS

As a provision of this contract the Contractor must divert at least fifty (50) percent of waste materials from landfills. The Contractor shall complete and submit the "Waste Assessment Form" found in Appendix B of these Special Provisions prior to the start of demolition work, demonstrating how this requirement will be fulfilled.

Special Provisions

Upon completion of all items of work the Contractor shall fill out and return the “Waste Assessment Summary Report Form” found in Appendix B of these Special Provisions. Supporting documentation such as receipts and weight tags must be provided for all jobsite construction and demolition materials recycled, reused off-site, or disposed of in a landfill. Final release of retention will not be made until this information is submitted to the Engineer.

Failure to meet the 50 percent diversion requirement will result in the forfeiture of 40% of the project retention.

SP5-07 PAYMENT

No separate payment will be made for conforming to the provisions of this section. Full compensation for conforming to all the provisions of this section shall be considered as included in the prices paid for various contract items of work and no additional compensation will be allowed therefor.

SPECIAL PROVISIONS SECTION SP-6

LEGAL RELATIONS AND RESPONSIBILITIES

(NO BID ITEM)

The provisions of Section 6, “Legal Relations and Responsibilities”, of the General Provisions of the Standard Specifications shall apply in their entirety and as supplemented herein, and in other related sections of these Special Provisions.

SP6-01 PUBLIC NOTIFICATIONS

SP6-01.01 RESIDENT NOTIFICATIONS

At least two weeks in advance of the start of work the Contractor shall provide the Engineer with the dates for pavement repair, crack sealing, slurry sealing, micro-surfacing and chip sealing work for each of the streets and parking lot listed in the Resident Notice found in Appendix E of these Special Provisions. The City of Lafayette will mail the notice to all residents and businesses within the limits of work at no cost to the Contractor.

SP6-01.02 EMERGENCY AND ALL OTHER NOTIFICATIONS

The Contractor shall notify all emergency, public transportation, post office, garbage/recycle collection, and school bus services by fax of the pending work, at least (1) week prior to the day the Contractor’s forces move on the project site, unless otherwise approved in writing by the Engineer.

In addition the Contractor shall notify all emergency, public transportation, post office, garbage/recycle collection, and school bus services by fax of all work requiring road closures a minimum of (2) days in advance of the work occurring. In the event the work is rescheduled the Contractor shall re-notify aforementioned agencies a minimum of (48 hours) in advance of the work occurring.

Contractor shall provide the Engineer with written confirmation of notices being sent prior to commencing the work covered by the notice.

Police (Business Office)	PH#925-283-3680	FAX#925-283-4126
Police Dispatch	PH#925-284-5010	FAX#925-313-2479
Fire	PH#925-941-3300	FAX#925-941-3309
American Medical Response	PH#888-650-8514	FAX#888-887-6112
County Connection Bus	PH#925-676-7500	FAX#925-687-7471
Lamorinda School Bus Program	PH#925-299-3216	FAX#925-283-2181
Durham School Services	PH#925-686-3391	FAX#925-689-1540
Allied Waste	PH#925-603-1144	FAX#925-685-4114
Valley Waste Management	PH#925-935-8900	FAX#1-877-575-3599
United States Post Office	PH#925-962-6955	FAX#925-962-1970

Special Provisions

SP6-01.03 COORDINATION WITH WASTE/RECYCLING OPERATIONS

The Contractor shall not impair or impede waste hauler and recycling operations scheduled to be conducted within the project area. It is the Contractor's responsibility to determine which waste hauler and recycling operators are scheduled to operate within the project area and to develop a project schedule that will not impair or impede the waste hauler or recycling operations.

At the time of publishing these specifications the waste and recycling pick-up days are as follows. The Contractor shall confirm this schedule with the waste and recycling companies prior to commencing his operations.

Happy Valley Road	Monday
Rahara Drive	Monday
El Nido Ranch Road	Monday
Middle Road	Tuesday
Knox Drive	Tuesday
Acalanes Road	Tuesday
Woodside Court	Tuesday
Dolores Drive	Monday
Happy Valley Court	Monday
Deer Hill Road	Friday
Brown Avenue	Monday
Second Street	Tuesday
School Street	Thursday
Topper Lane	Thursday
Hamilin Road	Thursday
Hawthorne Drive	Friday
Ridge Road	Friday
Oak View Court	Friday
Diablo Drive	Friday
Old Millstone Lane	Thursday
Las Trampas Road	Friday
Richelle Court	Friday
Anita Court	Friday
Old Tunnel Road	Friday
Camino Diablo	Wednesday
Nogales Street	Wednesday
Palomares Street	Wednesday
Nogales Court	Wednesday
Warner Court	Wednesday
Moraga Road	Thursday
East Terrace	Thursday
Glenside Drive	Friday
Glenside Circle	Friday
Los Palos Drive	Friday
Sharon Court	Thursday
Gold Court	Thursday
Antonio Court	Thursday
Lucas Circle	Thursday

Special Provisions

Lancaster Drive	Thursday
Crofton Court	Thursday
Kingsley Place	Thursday
Sommerset Place	Thursday
West Lowell Lane	Thursday
McBride Drive	Thursday
Green Acres Court	Thursday
Marsha Place	Thursday
Silverado Drive	Thursday
Ruppel Place	Thursday

SP6-02 PERMITS AND LICENSES

The Contractor shall procure all permits and licenses, pay all charges and fees, and give all notices necessary and incidental to the due and lawful prosecution of the work.

The City of Lafayette will obtain the required encroachment permits for work in or adjacent to the State Right of Way on El Nido Ranch Road, Brown Avenue and Camino Diablo. The Contractor shall comply with all conditions imposed by the California Department of Transportation.

SP6-03 CONTRACTORS LICENSING LAW

Contractor's License Classification: In accordance with the provisions of California Public Contract Code Section 3300, the owner has determined that the Contractor shall possess a valid Class "A" Contractor License at the time that the contract is awarded. Failure to possess the specified license shall render the bid as non-responsive and shall act as a bar to award of the contract to any bidder not possessing said license at the time of award.

SP6-04 CONTRACTOR'S COMPREHENSIVE GENERAL INSURANCE

Section 6-33.3, "Contractor's Comprehensive General Insurance", of the General Provisions of the Standard Specifications shall be modified to read:

These policies shall each provide the following minimum limits:

General Liability (Form CG00 01 12 07)	\$2,000,000 each occurrence (Combined single limit for bodily injury and property damage)
Product – Completed Operation	\$2,000,000 each occurrence
Automobile Liability Insurance	\$1,000,000 per accident for bodily injury or disease

The insurance policies are to contain, or be endorsed to contain, the following provisions:

Additional Insured Status: The City, its officers, officials, employees, agents, are to be covered as additional insured on the GL policy with respect to liability arising out of work or operations performed by or on behalf of the Contractor, including materials, parts, or equipment furnished in connection with such work or operations. General liability coverage can be provided in the form of an endorsement to the Contractor's insurance at least

Special Provisions

as broad as ISO Form CG 20 10 11 85 or, if not available, through the addition of both CG 20 10 and CG 20 37 if a later edition is used.

Primary Coverage: For any claims related to this contract, the Contractor's insurance coverage shall be primary insurance as respects the City, its officers, officials, employees, and agents.

SP6-05 BLANK

SP6-06 PAYMENT

No separate payment will be made for conforming to the provisions of this section. Full compensation for conforming to all the provisions of this section shall be considered as included in the prices paid for various contract items of work and no additional compensation will be allowed therefor.

SPECIAL PROVISIONS SECTION SP-7

EXISTING UTILITIES

(NO BID ITEM)

The provisions of Section 7, "Existing Utilities", of the General Provisions of the Standard Specifications shall apply in their entirety and as supplemented herein.

SP7-01 GENERAL

The Contractor shall coordinate and cooperate with the utility companies and schedule work in accordance with the order of work specified in Section SP5-04, "Order of Work", of these Special Provisions and the utility company work. In the event that coordination causes delay beyond the Contractor's control to the Contractor's controlling operations on the critical path, the Contractor shall notify the Engineer in writing and provide supporting documentation for the nature and magnitude of delay. The Engineer, upon concurrence with said delay notice, may grant additional contract working days up to a number equal to the delay claimed by Contractor. The Engineer's decision shall be final. Granting of additional contract working days shall be the Contractor's sole remedy for delay caused by utility coordination of work, and no additional claims for delay, inconvenience, or loss of production shall be allowed.

The Contractor's attention is directed to the utility notification service provided by UNDERGROUND SERVICE ALERT (USA). USA member utilities will provide the Contractor with the locations of their substructures in the construction area when the Contractor gives at least two (2) working days notice to the Underground Service Alert by calling 1-800-227-2600.

SP7-02 UTILITY PROTECTION, RELOCATION AND REARRANGEMENT

This project includes work on streets with overhead and buried utility and service lines. In some locations, these utility and service lines may have minimal clearance with existing and new facilities within the limits of work. It is the Contractor's responsibility to conduct his/her operations around the facilities such that the work is accomplished without damage to the utility lines. The Contractor shall notify each utility at least forty-eight (48) hours in advance of any work around these overhead and buried facilities, and shall satisfy all applicable requirements and safety standards for working in close proximity to these utility and service lines. The Contractor shall protect these utility facilities and arrange for supporting utility facilities, with the utility companies, when necessary.

SP7-03 PAYMENT

No separate payment will be made for conforming to the provisions of this section. Full compensation for conforming to all the provisions of this section shall be considered as included in the prices paid for various contract items of work and no additional compensation will be allowed therefor.

SPECIAL PROVISIONS SECTION SP-8

PROGRESS OF WORK (NO BID ITEM)

The provisions of Section 8, "Progress of Work", of the General Provisions of the Standard Specifications shall apply in their entirety and as supplemented herein.

SP8-01 PRE-CONSTRUCTION MEETING

A pre-construction meeting will be held at the office of the City of Lafayette, 3675 Mount Diablo Boulevard, Suite 210. At this conference, the Contractor shall submit all required bonds, insurance, and signed contracts. The Notice to Proceed will be issued to the Contractor at the pre-construction meeting.

At the pre-construction meeting, representatives of the Owner, the Contractor, Subcontractors, and the Engineer will discuss in detail certain procedural aspects of the work, including, but not limited to:

- Administrative procedures for transmittals, approvals, change orders, and similar items;
- Review of the method of application for payment, progress payments, retention; and final payment;
- Review of the Contractor's construction schedule;
- Clarifications of any questions regarding the contract Plans and Special Provisions;
- Review of traffic control and noticing procedures;
- At the preconstruction meeting the Contractor shall provide a traffic control plan.

SP8-02 PROGRESS SCHEDULE

The Contractor shall submit the construction progress schedule to the Engineer at the pre-construction meeting and updated schedules every two (2) weeks and as requested by the Engineer as the work progresses as stated in Section 8-2, "Progress Schedule", of the General Provisions of the Standard Specifications.

Attention is directed to Section SP5-04, "Order of Work", of these Special Provisions. Each schedule shall specifically note the timeframe and work to be performed by all subcontractors. Subcontractors shall receive all updated schedules so they can plan an appropriate work force to meet the prime Contractor's timeframe.

SP8-03 WORKING HOURS

Without prior written approval by the Engineer, and except for emergency work, work or activity of any kind shall be limited to the hours from 8:00 a.m. to 5:00 p.m. Monday through Friday. The Contractor's attention is

Special Provisions

directed to Section SP14-05, "Lane Closure Hours", Section SP14-06, "Parking Lot Closure Hours", and Section SP14-07, "Street Closure Hours" of these Special Provisions.

SP8-04 TIME OF COMPLETION AND LIQUIDATED DAMAGES

The Contractor shall complete the entire work in this contract within **forty (40)** working days from the original start date including completion of all "Punch List" work. The Contractor's attention is directed to Section 8-10, "Liquidated Damages", of the General Provisions of the Standard Specifications.

Completion of contract work is defined as completion of all items listed in the Bid Schedule and any issued Contract Change Order for the project, regardless of substantial use or benefit of any work in progress or portion of the project. "Punch List" items are considered to be a part of work items on the Bid Schedule.

Contract working days shall continue to be counted for the purpose of determining time of completion and liquidated damages until the completion of contract work as defined above, including completion of "Punch List" work.

SP8-05 CONTRACT CHANGES, CHANGE ORDERS AND EXTRA WORK

Contractor's attention is directed to Section 8-6 of the General Provisions to the Standard Specifications and SP12-01 of these Special Provisions.

Section 9-3.4.7 "Markups" of the General Provisions to the Standard Specifications shall not apply to this contract. Extra work payment shall conform to Section 9-1.03, "Force Account Payment", of the State of California Department of Transportation Standard Specifications dated May 2006.

SP8-06 PAYMENT

No separate payment will be made for conforming to the provisions of this section. Full compensation for conforming to all the provisions of this section shall be considered as included in the prices paid for various contract items of work and no additional compensation will be allowed therefor.

SPECIAL PROVISIONS SECTION SP-9

MEASUREMENT AND PAYMENT

(NO BID ITEM)

The provisions of Section 9, "Measurement and Payment", of the General Provisions of the Standard Specifications shall apply in their entirety except as noted in Section SP8-05 "Contract Changes, Change Orders and Extra Work" and as supplemented herein.

SP9-01 PAYMENT

No separate payment will be made for conforming to the provisions of this section. Full compensation for conforming to all the provisions of this section shall be considered as included in the prices paid for various contract items of work and no additional compensation will be allowed therefor.

SPECIAL PROVISIONS SECTION SP-10

NOT USED

SPECIAL PROVISIONS SECTION SP-11

MISCELLANEOUS (NO BID ITEMS)

SP11-01 PREVAILING WAGE.

Attention is directed to Section 7-1.01A(2), "Prevailing Wage," of the State Standard Specifications.

The general prevailing wage rates determined by the Director of Industrial Relations, for the county or counties in which the work is to be done, are available at the City of Lafayette, 3675 Mount Diablo Boulevard, Suite 210, Lafayette, CA, 94549. State of California Prevailing Wage may be found on the City of Lafayette website <http://www.ci.lafayette.ca.us> (click on Capital Improvements under the Quick Links sidebar on the homepage).

The Contractor and each subcontractor shall keep an accurate record showing the names and occupations of all laborers, workers, and mechanics employed in connection with the execution of this Agreement and each subcontractor thereunder, and showing also the actual per diem wages paid to each of such workers. This record shall be open at all reasonable hours to the inspection of the City and authorized entities of the State of California.

SP11-02 REMOVAL OF ASBESTOS AND HAZARDOUS SUBSTANCES

When the presence of asbestos or hazardous substances are not shown on the Plans or indicated in the specifications and the Contractor encounters materials which the Contractor reasonably believes to be asbestos or a hazardous substance as defined in Section 25914.1 of the Health and Safety Code, and the asbestos or hazardous substance has not been rendered harmless, the Contractor may continue work in unaffected areas reasonably believed to be safe. The Contractor shall immediately cease work in the affected area and report the condition to the Engineer in writing.

In conformance with Section 25914.1 of the Health and Safety Code, removal of asbestos or hazardous substances including exploratory work to identify and determine the extent of the asbestos or hazardous substance will be performed by separate contract.

If delay of work in the area delays the current controlling operation, the delay will be considered a right of way delay and the Contractor will be compensated for the delay in conformance with the provisions in 8-5 of the General Provisions.

SP11-03 PROMPT PROGRESS PAYMENT TO SUBCONTRACTORS

A prime contractor or subcontractor shall pay any subcontractor not later than 10 days of receipt of each progress payment in accordance with the provision in Section 7108.5 of the California Business and Professions Code concerning prompt payment to subcontractors, unless a longer period is agreed to in writing by the parties. Any delay or postponement of payment over 30 days may take place only for good cause and with the City's prior written approval. Any violation of Section 7108.5 shall subject the violating contractor or subcontractor to the penalties, sanction, and other remedies of that section. This requirement shall not be construed to limit or impair any contractual, administrative, or judicial remedies otherwise available to the contractor or subcontractor in the event of a dispute involving late payment or nonpayment by the prime contractor, deficient subcontract performance, or noncompliance by a subcontractor.

SPECIAL PROVISIONS SECTION SP-12

MOBILIZATION
(BID ITEM NOS. 1 AND 2)

The provisions of Section 1, "Mobilization", of the Technical Provisions of the Standard Specifications shall apply in their entirety except as modified or supplemented herein.

SP12-01 INCREASE OR DECREASE IN BONDING

When the final contract price for which the Contractor has bonded for a project increases by over 25% of the original base bid price due to change orders and/or increases in the quantities of items incorporated into the project, the Contractor shall be entitled to payment for additional bonding costs that have been paid to the surety company due to this increase. Payment for this cost shall be made via change order and included on the final project billing statement with supporting documentation from Contractor.

When the final contract price decreases by over 25% of the original base bid price due to change orders and/or a decrease in the quantities of items incorporated into the project, the City shall be entitled to a reimbursement of the decrease in bonding costs paid by the Contractor. The refund of these costs shall be made via change order and deducted from the final payment for release of retention.

SP12-02 STAGING AREA

The Contractor may stage materials and equipment in existing legal parking spaces within the project limits when authorized by the Engineer and protected by barricades with flashers.

At this time only one City-owned site is available for the staging of equipment and materials. This site is located on the south side of Mount Diablo Boulevard adjacent to the intersection of Mount Diablo Boulevard and El Nido Ranch Road. This site may be used on the condition that all materials brought onto the site shall be completely removed within 48 hours of completion of the work that requires staging on this site. Failure to vacate the site within five calendar days of the substantial completion of work will result in rent of \$1,000 per day being deducted from monies owed the Contractor. Retention and rent owed shall be withheld until the site is vacated and restored to preexisting condition or better. The Contractor will be responsible for installing construction fencing along the property line as shown in the drawing in Appendix C of these specifications. The Contractor shall be responsible for the protection of the site and the removal of any materials placed on the site while the site is under his/her control. The site may not be used until the Contractor is ready to actively execute work contained in the contract. At no time shall any maintenance of equipment or vehicles be performed on said site.

It is the Contractor's responsibility to inspect the site to determine its suitability for his operations to execute this contract. The City makes no guarantee, expressed or implied that this subject area is appropriate for the work involved. It is the Contractor's responsibility to secure a staging area for contract work, and any associated costs are considered to be included in the various contract prices paid, with no additional compensation allowed therefor.

Special Provisions

Aside from City-owned properties, the Contractor's proposed staging site shall be approved by the Engineer, and the Contractor shall submit proof of an agreement for use of said staging area with private property owner(s) prior to mobilization. Upon approval, Contractor shall obtain a temporary land use permit from the City of Lafayette Planning Division for use of subject site for staging. The City does not guarantee the granting of said permit as part of this contract. Contractor shall bear all costs to secure said permit.

The staging area shall be maintained throughout the duration of the project such that it is not construed as visual blight in the opinion of the Engineer. All adjoining streets, sidewalks and gutters shall be swept free of construction materials tracked onto them at the end of each day. Failure to do so will result in City forces cleaning the area at the Contractor's expense. The City of Lafayette labor rate to be used shall be \$150 per hour per person.

SP12-03 PROJECT NOTIFICATION AND RE-NOTIFICATION SIGNS

The Contractor shall provide and install Project Notification signs at all entrances and exits from the limits of work with a minimum of two signs required per street or parking lot. The signs shall be printed with black lettering on a yellow background and shall have text similar to the example sign found in Appendix F of these Special Provisions. The signs shall be a minimum of 3 feet wide by 3 feet tall and shall state the phase of work (Pavement Repair, Crack Seal, Chip Seal and Slurry Seal) as well as the dates and times for this work. The signs may be printed on paper mounted to plywood. The contractor shall mount the signs to a Type III barricade. The Contractor shall submit a proof set for all notification signs to the Engineer for review and approval prior to manufacturing the signs. The notification sign for the initial phase of work shall be in place on the project site a minimum of (5) working days in advance of performing work on the street or parking lot. All subsequent phases of work shall have notification signs in place a minimum of (2) working days in advance of the start of work.

If any phase of work identified in the written Notice to Residents or subsequent Project Notification sign is not undertaken on the date or dates and time identified, the street or parking lot shall be re-notified with updated sign boards in accordance with these special provisions. Re-notification signs shall be provided and installed by the contractor a minimum of (48) hours in advance of performing work on the street or parking lot. The Contractor shall submit a proof set for all re-notification signs to the Engineer for review and approval prior to manufacturing the signs.

The Contractor shall install and maintain the project notification and re-notification signs in legible condition at all times during the contract duration.

SP12-04 SANITARY RESTROOM FACILITIES

Sanitary restroom facilities shall be provided and maintained, by the Contractor, on the project site. The Contractor's proposed locations for restroom facilities shall be reviewed with the Engineer prior to delivery of the restroom facility. If the Contractor and/or subcontractors are working at multiple sites simultaneously, then a restroom facility will be required at each site. Failure to provide sanitary restroom facilities is grounds for suspension of work. Contractor shall note that the count of working days will continue.

Special Provisions

SP12-05 HAULING EQUIPMENT SIZE AND WEIGHT LIMITATIONS

Only 10-wheel type dump trucks or “transfer” type trucks with trailers will be allowed for off-hauling material from the jobsite or hauling material to the jobsite. 10-wheel trucks with extra axles, or “super-dumps”, will not be allowed.

SP12-06 WATER POLLUTION CONTROL

Water pollution control work shall conform to the provisions in Section 7-1.01G, "Water Pollution", of the State Specifications and these Special Provisions.

Water pollution control work shall conform to the requirements in the "Storm Water Pollution Prevention Plan (SWPPP) and Water Pollution Control Program (WPCP) Preparation Manual" and the "Construction Site Best Management Practices (BMPs) Manual," and addenda thereto issued up to, and including, the date of advertisement of the project. These manuals are hereinafter referred to respectively as the "Preparation Manual" and the "Construction Site BMPs Manual", and collectively, as the "Manuals". Copies of the Manuals may be obtained from the Department of Transportation, Material Operations Branch, Publication Distribution Unit, 1900 Royal Oaks Drive, Sacramento, California 95815, Telephone: (916) 445-3520, and may also be obtained from the Department's Internet website at: <http://www.dot.ca.gov/hq/construc/stormwater>

The Contractor shall know and fully comply with applicable provisions of the Manuals, and Federal, State, and local regulations and requirements that govern the Contractor's operations and storm water and non-storm water discharges from both the project site and areas of disturbance outside the project limits during construction. Attention is directed to Sections 7-1.01, "Laws to be Observed", and 7-1.12, "Indemnification and Insurance", of the State Standard Specifications.

Water pollution control requirements shall apply to storm water and non-storm water discharges from areas outside the project site which are directly related to construction activities for this contract including, but not limited to, staging areas, storage yards and access roads. The Contractor shall comply with the Manuals for those areas and shall implement, inspect and maintain the required water pollution control practices. Installing, inspecting and maintaining water pollution control practices on areas outside the project limits not specifically arranged and provided for by the City for the execution of this contract, will not be paid for.

The Contractor shall be responsible for penalties assessed or levied on the Contractor or the City as a result of the Contractor's failure to comply with the provisions in this section "Water Pollution Control" including, but not limited to, compliance with the applicable provisions of the Manuals, and Federal, State and local regulations and requirements as set forth therein.

Penalties as used in this section shall include fines, penalties and damages, whether proposed, assessed, or levied against the City or the Contractor, including those levied under the Federal Clean Water Act and the State Porter-Cologne Water Quality Control Act, by governmental agencies or as a result of citizen suits. Penalties shall also include payments made or costs incurred in settlement for alleged violations of the Manuals, or applicable laws, regulations, or requirements. Costs incurred could include sums spent instead of penalties, in mitigation or to remediate or correct violations.

Special Provisions

SP12-06.01 RETENTION OF FUNDS

Notwithstanding any other remedies authorized by law, the City may retain money due the Contractor under the contract, in an amount determined by the City, up to and including the entire amount of penalties proposed, assessed, or levied as a result of the Contractor's violation of the Manuals, or Federal or State law, regulations or requirements. Funds may be retained by the City until final disposition has been made as to the penalties. The Contractor shall remain liable for the full amount of penalties until such time as they are finally resolved with the entity seeking the penalties.

Retention of funds for failure to conform to the provisions in this section, "Water Pollution Control", shall be in addition to the other retention amounts required by the contract. The amounts retained for the Contractor's failure to conform to provisions in this section will be released for payment on the next monthly estimate for partial payment following the date when an approved WPCP has been implemented and maintained, and when water pollution has been adequately controlled, as determined by the Engineer.

When a regulatory agency identifies a failure to comply with the Manuals, or other Federal, State or local requirements, the City may retain money due the Contractor, subject to the following:

- A. The City will give the Contractor seventy-two (72) hours' notice of the City's intention to retain funds from partial payments which may become due to the Contractor prior to acceptance of the contract. Retention of funds from payments made after acceptance of the contract may be made without prior notice to the Contractor.

During the first progress payment period after that the Contractor fails to conform to the provisions in this section, "Water Pollution Control", the City may retain an amount equal to 25 percent of the estimated value of all contract work performed on the entire contract.

The Contractor shall notify the Engineer immediately upon request from the regulatory agencies to enter, inspect, sample, monitor, or otherwise access the project site or the Contractor's records pertaining to water pollution control work. The Contractor and the City shall provide copies of correspondence, notices of violations, enforcement actions or proposed fines by regulatory agencies to the requesting regulatory agency.

SP12-06.02 WATER POLLUTION CONTROL PROGRAM PREPARATION, APPROVAL AND AMENDMENTS

As part of the water pollution control work, a Water Pollution Control Program (WPCP) is required for this contract. The WPCP shall conform to the provisions in Section 7-1.01G, "Water Pollution", of the State Specifications, the requirements in the Manuals, and these Special Provisions. Upon the Engineer's approval of the WPCP, the WPCP shall be considered to fulfill the provisions in Section 7-1.01G, "Water Pollution", of the State Standard Specifications for development and submittal of a Water Pollution Control Program.

No work having potential to cause water pollution, shall be performed until the WPCP has been approved by the Engineer. Approval shall not constitute a finding that the WPCP complies with applicable requirements of the Manuals and applicable Federal, State and local laws, regulations, and requirements.

The Contractor shall designate a Water Pollution Control Manager. The Water Pollution Control Manager shall be responsible for the preparation of the WPCP and required modifications or amendments, and shall be responsible for the implementation and adequate functioning of the various water pollution control practices employed. The Contractor may designate different Water Pollution Control Managers to prepare the WPCP and

Special Provisions

to implement the water pollution control practices. The Water Pollution Control Managers shall serve as the primary contact for issues related to the WPCP or its implementation. The Contractor shall assure that the Water Pollution Manager(s) have adequate training and qualifications necessary to prepare the WPCP, implement and maintain water pollution control practices.

Within ten (10) working days after the approval of the contract, the Contractor shall submit two (2) copies of the draft WPCP to the Engineer. The Engineer will have ten (10) working days to review the WPCP. If revisions are required, as determined by the Engineer, the Contractor shall revise and resubmit the WPCP within ten (10) working days of receipt of the Engineer's comments. The Engineer will have five (5) working days to review the revisions. Upon the Engineer's approval of the WPCP, one (1) approved copy of the WPCP, incorporating the required changes, shall be submitted to the Engineer. In order to allow construction activities to proceed, the Engineer may conditionally approve the WPCP while minor revisions are being completed. In the event the Engineer fails to complete the review within the time allowed, and if, in the opinion of the Engineer, completion of the work is delayed or interfered with by reason of the Engineer's delay in completing the review, the Contractor will be compensated for resulting losses, and an extension of time will be granted, in the same manner as provided for in Section 8-1.09, "Right of Way Delays", of the State Specifications.

The WPCP shall incorporate water pollution control practices in the following categories:

- A. Soil stabilization.
- B. Sediment control.
- C. Wind erosion control.
- D. Tracking control.
- E. Non-storm water management.
- F. Waste management and materials pollution control.

The Contractor shall develop a Water Pollution Control Schedule that describes the timing of grading or other work activities that could affect water pollution. The Water Pollution Control Schedule shall be updated by the Contractor to reflect changes in the Contractor's operations that would affect the necessary implementation of water pollution control practices.

The Contractor shall prepare an amendment to the WPCP when there is a change in construction activities or operations which may affect the discharge of pollutants to surface waters, ground waters, municipal storm drain systems, or when the Contractor's activities or operations violate Federal, State or local regulations, or when directed by the Engineer. Amendments shall identify additional water pollution control practices or revised operations, including those areas or operations not identified in the initially approved WPCP. Amendments to the WPCP shall be prepared and submitted for review and approval within a time approved by the Engineer, but in no case longer than the time specified for the initial submittal and review of the WPCP.

The Contractor shall keep one copy of the approved WPCP and approved amendments at the project site. The WPCP shall be made available upon request by a representative of the Regional Water Quality Control Board, State Water Resources Control Board, United States Environmental Protection Agency, or the local storm water management agency. Requests by the public shall be directed to the Engineer.

No adjustment in compensation will be made for ordered changes to correct WPCP work resulting from the Contractor's own operations or from the Contractor's negligence.

If requested by the Contractor and approved by the Engineer, changes to the water pollution control plan, including addition of new water pollution control practices, will be allowed. Changes shall be included in the

Special Provisions

approved amendment of the WPCP. If the requested changes result in a net cost increase to the lump sum price for water pollution control, an adjustment in compensation will be made without change to the water pollution control item. The net cost increase to the water pollution control item will be paid for as extra work as provided in Section 4-1.03D, "Extra Work", of the State Specifications.

SP12-06.03 WPCP IMPLEMENTATION

Unless otherwise specified, upon approval of the WPCP, the Contractor shall be responsible throughout the duration of the project for installing, constructing, inspecting, maintaining, removing, and disposing of the water pollution control practices specified in the WPCP and in the amendments. Unless otherwise directed by the Engineer, the Contractor's responsibility for WPCP implementation shall continue throughout any temporary suspension of work ordered in conformance with the provisions in Section 8-1.05, "Temporary Suspension of Work", of the State Specifications. Requirements for installation, construction, inspection, maintenance, removal, and disposal of water pollution control practices shall conform to the requirements in the Manuals and these special provisions.

If the Contractor or the Engineer identifies a deficiency in the implementation of the approved WPCP or amendments, the deficiency shall be corrected immediately. The deficiency may be corrected at a later date and time if requested by the Contractor and approved by the Engineer in writing, but shall be corrected prior to the onset of precipitation. If the Contractor fails to correct the identified deficiency by the date agreed or prior to the onset of precipitation, the project shall be in nonconformance with this section. Attention is directed to Section 5-1.01, "Authority of Engineer", of the State Specifications, and to "Retention of Funds" of this section for possible nonconformance penalties.

If the Contractor fails to conform to the provisions of this section, "Water Pollution Control", the Engineer may order the suspension of construction operations until the project complies with the requirements of this section.

Implementation of water pollution control practices may vary by season. The Construction Site BMPs Manual and these special provisions shall be followed for control practice selection of year-round, rainy season and non-rainy season water pollution control practices.

Year-Round Implementation Requirements

The Contractor shall have a year-round program for implementing, inspecting and maintaining water pollution control practices for wind erosion control, tracking control, non-storm water management, and waste management and materials pollution control.

The National Weather Service weather forecast shall be monitored and used by the Contractor on a daily basis. An alternative weather forecast proposed by the Contractor may be used if approved by the Engineer. If precipitation is predicted, the necessary water pollution control practices shall be deployed prior to the onset of the precipitation.

Disturbed soil areas shall be considered active whenever the soil disturbing activities have occurred, continue to occur or will occur during the ensuing 21 days. Nonactive areas shall be protected as prescribed in the Construction Site BMPs Manual within 14 days of cessation of soil disturbing activities or prior to the onset of precipitation, whichever occurs first.

Rainy Season Implementation Requirements

Special Provisions

Soil stabilization and sediment control practices conforming to the requirements of these special provisions shall be provided throughout the rainy season, defined as between October 15th and April 15th.

An implementation schedule of required soil stabilization and sediment control practices for disturbed soil areas shall be completed no later than 20 days prior to the beginning of each rainy season. The implementation schedule shall identify the soil stabilization and sediment control practices and the dates when the implementation will be 25 percent, 50 percent and 100 percent complete, respectively. For construction activities beginning during the rainy season, the Contractor shall implement applicable soil stabilization and sediment control practices.

Non-Rainy Season Implementation Requirements

The non-rainy season shall be defined as days outside the defined rainy season. The Contractor's attention is directed to the Construction Site BMPs Manual for soil stabilization and sediment control implementation requirements on disturbed soil areas during the non-rainy season. Disturbed soil areas within the project shall be protected in conformance with the requirements in the Construction Site BMPs Manual with an effective combination of soil stabilization and sediment control.

SP12-06.04 MAINTENANCE

To ensure the proper implementation and functioning of water pollution control practices, the Contractor shall regularly inspect and maintain the construction site for the water pollution control practices identified in the WPCP. The construction site shall be inspected by the Contractor as follows:

- A. Prior to a forecast storm.
- B. After a precipitation event which causes site runoff.
- C. At 24 hour intervals during extended precipitation events.
- D. Routinely, a minimum of once every two weeks outside of the defined rainy season.
- E. Routinely, a minimum of once every week during the defined rainy season.

The Contractor shall use the Storm Water Quality Construction Site Inspection Checklist provided in the Preparation Manual or an alternative inspection checklist provided by the Engineer. One copy of each site inspection record shall be submitted to the Engineer within 24 hours of completing the inspection.

SP12-06.05 REPORTING REQUIREMENTS

If the Contractor identifies discharges into surface waters or drainage systems in a manner causing, or potentially causing, a condition of pollution, or if the project receives a written notice or order from a regulatory agency, the Contractor shall immediately inform the Engineer. The Contractor shall submit a written report to the Engineer within seven (7) days of the discharge event, notice or order. The report shall include the following information:

- A. The date, time, location, nature of the operation, and type of discharge, including the cause or nature of the notice or order.

Special Provisions

- B. The water pollution control practices deployed before the discharge event, or prior to receiving the notice or order.
- C. The date of deployment and type of water pollution control practices deployed after the discharge event, or after receiving the notice or order, including additional measures installed or planned to reduce or prevent reoccurrence.
- D. An implementation and maintenance schedule for affected water pollution control practices.

SP12-07 MEASUREMENT AND PAYMENT

The lump sum contract price paid for “**Mobilization**” shall include full compensation for furnishing all labor, supervision, materials, tools, equipment and incidentals, and for all the work involved in mobilization, including, but not limited to, furnishing all specified contract bonds and insurance certificates, public notification, transporting equipment, establishing a storage area, sanitary restroom facilities, water pollution control and all other work as specified in the Standard Specifications and these Special Provisions and as directed by the Engineer and no additional compensation will be allowed therefor.

Compensation for providing and complying with the requirements for the water pollution control, including furnishing all labor, supervision, materials, tools, equipment, and incidentals, and for doing all the work involved in installing, constructing, maintaining, removing, and disposing of water pollution control practices, including non-storm water management, and waste management and materials pollution water pollution control practices, and other necessary work shall be considered as included in the contract lump sum price paid for “Mobilization” and no additional compensation will be allowed therefor.

The lump sum contract price paid for “**Project Notification Signs**” shall include full compensation for preparing and providing sign proof sets, furnishing all labor, supervision, materials, tools, equipment and incidentals, and for doing all the work involved in fabricating, transporting, installing, maintaining, and removing the sign and barricade as specified in the Standard Specifications and these Special Provisions and as directed by the Engineer and no additional compensation will be allowed therefor.

SPECIAL PROVISIONS SECTION SP-13

CONSTRUCTION AREA SIGNS

(BID ITEM NO. 3)

SP13-01 GENERAL

Construction area signs shall be furnished, installed, maintained, and removed when no longer required, in accordance with the provisions in Section 12-3.06, "Construction Area Signs", of the State Specifications and these Special Provisions.

The Engineer shall approve all locations prior to Contractor installing signs.

SP13-02 SIGNS, PANELS, AND POSTS

Construction area sign panels shall be metal, with reflective coating, black lettering on orange background, and mounted Type III barricades and shall conform to Section 12-3.06B, "Portable Signs", of the State Specifications. Signs shall be kept clean and in good repair.

SP13-03 MEASUREMENTS AND PAYMENT

The contract price paid per lump sum for "**Construction Area Sign**" shall be considered as full compensation for furnishing all labor, supervision, materials, tools, equipment and incidentals, and for doing all work involved in furnishing, erecting, maintaining, and removing all construction area signs, as shown on the Plans, as specified in these Special Provisions, and as directed by the Engineer, and no additional compensation will be allowed therefor.

SPECIAL PROVISIONS SECTION SP-14

TRAFFIC CONTROL

(BID ITEM NO. 4)

SP14-01 GENERAL

Traffic control shall conform to the requirements of Section 6-12, "Traffic Control", of the General Provisions of the Standard Specifications, Sections 7-1.08, "Public Convenience", 7-1.09, "Public Safety", and 12, "Construction Area Traffic Control Devices", of the State Specifications and these Special Provisions. Nothing in these Special Provisions shall be construed as relieving the Contractor from his/her responsibilities as specified in said sections.

All signs, barriers, barricades, steel plates, and other traffic control devices shall be furnished and maintained, including all needed repairs, by the Contractor. Work shall conform with the latest edition of the "California Manual on Uniform Traffic Control Devices" and Section 12, "Construction Area Traffic Control Devices", of the State Specifications. All necessary signs and traffic control devices shall be furnished, installed and maintained, and removed when no longer needed, by the Contractor.

SP14-02 TRAFFIC CONTROL PLAN

Prior to starting work, the Contractor shall prepare and submit a detailed proposed traffic control plan to the Engineer. The traffic control plan shall provide sufficient information and details to show detours, typical lane closures, channelizing, locations and usage of flagmen, construction zone signing, and provisions for pedestrians, for each street and location of work. The traffic control plan shall show in detail, the proposed sequencing of the work together with the proposed traffic control system for each work task. The proposed traffic control system shall, in all respects, satisfy the requirements of these Special Provisions. The Engineer will review the proposed traffic control plan and return it to the Contractor for any necessary revisions or corrections. The Contractor shall revise and resubmit the plan to the Engineer, and this process shall be repeated, until the proposed traffic control plan is accepted by the Engineer. The Contractor will not be permitted to perform any lane closures or implement any part of the traffic control plan until it has been accepted by the Engineer.

SP14-03 DRIVEWAY CLOSURES

Driveways that are closed to access shall be coned off or barricaded.

SP14-04 LANE CLOSURES

"Traffic Lane" shall be defined as that portion of the roadway for the movement of a single line of vehicles.

"Lane Closure" shall be defined as the temporary closure of a portion or the full width of an existing traffic lane. The temporary shifting of an existing traffic lane to shoulders, parking areas, medians or other areas of the roadway shall be considered a lane closure.

Special Provisions

At least one ten (10) foot wide vehicular traffic lane must be open to public traffic at all times, when work is in progress, for all contract work. A minimum of two (2) flagmen are required when lane closures result in only one (1) open lane for two-directional traffic. The Contractor shall provide communication equipment, approved by the Engineer for flagmen. Flagmen shall be capable of relaying information regarding the anticipated duration of the closure, how to proceed through the traffic control limits and answer any questions related to access to properties and businesses. **Flagmen shall remain in place until the entire width of the roadway has been opened to the public.**

Lane closures shall conform to the details shown on State Standard Plan T13, "Traffic Control System for Lane Closure on Two Lane Conventional Highways".

SP14-05 LANE CLOSURE HOURS

Lane closures will be allowed between the hours of 8:00 A.M. and 5:00 P.M., Monday through Friday. Emergency vehicles shall be provided with immediate access through the construction area at all times. If work is not in progress during allowed lane closure hours and a traffic lane is closed, the Engineer may order the lane opened to public traffic.

SP14-06 PARKING LOT CLOSURE AND HOURS

Parking lot closures shall be permitted during all phases of the work to be performed on the parking lot. Parking lot closures will be allowed between the hours of 7:00 A.M. and 5:00 P.M., Monday through Friday.

SP14-07 ROAD CLOSURE AND HOURS

Road closures shall only be permitted during the chip seal, slurry seal or micro-surfacing phase of work, except that no road closure is allowed on School Street and Topper Lane.

Road closures hours shall be as follows:

- June 10, 2013, through August 16, 2013, road closure hours shall be 8:30 a.m. to 4:30 p.m. Monday through Friday, excluding holidays.
- Prior to June 10th and after August 16, 2013, road closure hours shall be 9:30 to 2:00 p.m. Monday through Friday, excluding holidays.

The Contractor may work under lane closure conditions specified in Section SP14-5 "Lane Closure Hours" before and after the specified road closure hours.

The Contractor shall coordinate road closures with garbage and recycling collection as well as accommodate residents with medical, health and safety-related needs (e.g. doctor appointments, emergency access, and access requirements due to residents with physical disabilities).

The full width of the traveled way shall be open for use by public traffic at all other times. Emergency vehicles shall be provided immediate access through the construction area at all times. If work is not in progress during allowed closure hours, the Engineer may order the road opened to public traffic.

Special Provisions

A flagperson must remain at street access points to the road closure at all times to prevent unauthorized access into the road closure zone.

SP14-08 MAINTAINING TRAFFIC

Pedestrian access shall be provided at all times through the construction areas.

Vehicular access to private properties shall be maintained outside of the road closure limits. Vehicular access to private properties, at all other times, shall be maintained during construction, except under certain conditions. Contractor may interrupt access when the driveway access interruptions are coordinated with the property owner and the Engineer. In such cases, the Contractor shall obtain permission from the Engineer in advance, and provide written notification to the affected parties forty-eight (48) hours in advance. The Contractor shall further give one (1) hour notice to affected parties prior to restricting vehicular access.

SP14-09 ADDITIONAL CONSTRUCTION SIGNS AND CONTROLS

In addition to the requirements of Section 6-12, "Traffic Control," of the General Provisions of the City of Lafayette Standard Specifications and Section 12, "Construction Area Traffic Control Devices," of the State Specifications and these Special Provisions, the following traffic controls will be required. "Road Work Ahead" (type W20-1) signs shall be placed on all public road approaches to the project site before any work commences on the project. C-6 "Loose Gravel" and W-6 (15 MPH), signs shall be used on all streets receiving the chip/slurry seals. All construction signs shall be reflective. These signs shall be maintained for the duration of the construction and shall be removed once construction is complete.

The Contractor shall provide temporary stands or poles on which to place the required signs.

"LOOSE GRAVEL", (C-6), signs shall be furnished and placed adjacent to both sides of the traveled way on each block where chip seal screenings are being spread on a traffic lane. Additional signs shall be placed at a maximum of 500-foot intervals and at public roads entering the construction area as directed by the Engineer. The C-6 signs shall be maintained in place at each location until final brooming of the surface at that location is performed. C-6 signs shall conform with the requirements for construction area signs in Section 12, "Construction Area Traffic Control Devices," of the State Specifications.

SP14-10 PUBLIC PARKING

At locations where parking will be prohibited, the Contractor shall place "No parking signs" on Type II barricades at least three (3) days prior to parking restrictions. A minimum of one barricade shall be placed between driveways and the spacing of barricades shall not exceed 100 feet. The "No parking signs" shall clearly show the dates and times of proposed parking restrictions. Parking restriction times shall conform to the lane closure hours listed in Section SP-13, "Traffic Control" of these Special Provisions.

SP14-11 FAILURE TO COMPLY

Failure to comply with the requirements and provisions in this section shall be sufficient cause for the Engineer to suspend the work in accordance with the provisions of Section 8-3, "Temporary Suspension of the Work", of the General Provisions of the Standard Specifications. In the event the Engineer orders a suspension of the work due to the failure of the Contractor to comply with the requirements of this section, the days on which the suspension order is in effect shall be considered as working days if such days are working days as set forth in

Special Provisions

Section 8-9, "Time of Completion", of the General Provisions of the Standard Specifications. The Contractor will not be permitted to resume the work until such time as he/she has satisfactorily demonstrated to the Engineer his/her ability to perform the work in accordance with the provisions of the contract.

If a closure is not reopened to public traffic by the specified time, work shall be suspended in conformance with the provisions in Section 8-3, "Temporary Suspension of the Work", of the General Provisions of the Standard Specifications. The Contractor shall not make any further closures until the Engineer has accepted a work plan, submitted by the Contractor, which will insure that future closures will be reopened to public traffic at the specified time. The Engineer will have 2 working days to accept or reject the Contractor's proposed work plan. The Contractor will not be entitled to any compensation for the suspension of work resulting from the late reopening of closures.

For each 10-minute interval, or fraction thereof past the time specified to reopen the road or lane closure, the City shall deduct \$100.00 per interval per street from money due or that may become due to the Contractor under the contract.

Minor deviations from the requirements of this section concerning hours of work which do not alter the Contract price may be permitted upon the written request of the Contractor if, in the opinion of the Engineer, public traffic will be better served and the work expedited. These deviations shall not be adopted by the Contractor until the Engineer has approved the deviations in writing.

SP14-12 MEASUREMENT AND PAYMENT

The contract lump sum price paid for "**Traffic Control**" shall be considered as full compensation for furnishing all labor, supervision, materials, tools, equipment and incidentals needed to perform all traffic control work, for all phases of the work performed by the Contractor or the Contractor's "subcontractors" including, but not limited to, all signs, barricades, arrow boards, steel plates, traffic control plan, detour plan, maintaining traffic, lane closures, detours, flagmen and all other traffic control devices; and all other work as shown on the State Standard Plans, as specified in the Standard Specifications, the State Specifications, these Special Provisions and as directed by the Engineer and no additional compensation shall be allowed therefor. There shall be no additional compensation for traffic control due to an increase in the quantities shown on the bid proposal for pay items within the project limits.

Traffic Control required by work which is classified as extra work, as provided in Section 9.3, "Extra Work", of the General Provisions of the Standard Specifications, will be paid for as part of said extra work.

The full costs of furnishing all flaggers under the provisions of this section and Sections 7-1.08, 7-1.09, and 12-2.02 of the State Specifications will be borne by the Contractor and shall be considered as included in the price paid for "Traffic Control" and no additional compensation shall be allowed therefor.

SPECIAL PROVISIONS SECTION SP-15

DUST CONTROL
(NO BID ITEM)

The provisions of Section 4, "Dust Control and Watering", of the Technical Provisions of the Standard Specifications shall apply in their entirety and as supplemented herein.

SP15-01 GENERAL

The contract work occurs adjacent to existing residences. Contractor shall undertake all reasonable measures to minimize the presence and impacts of dust in the work area and on the adjacent residences.

Leaf blowers shall not be used to remove debris from the project streets. Debris removal shall be performed in such a way as to minimize dust.

Whenever the Engineer deems dust control to be necessary, the Contractor shall furnish and apply control measures to alleviate the problem. The Engineer shall specify a dust palliative or control measure in accordance with the provisions of the Standard Specifications, which the Contractor shall furnish and apply.

SP15-02 PAYMENT

No separate payment shall be made for conforming to the provisions of this section. Full compensation for conforming to all the provisions of this section shall be considered as included in the prices paid for various contract items of work and no additional compensation shall be allowed therefor.

SPECIAL PROVISIONS SECTION SP-16

**CLEARING AND GRUBBING, TREE TRIMMING
AND TREE PROTECTION**
(BID ITEM NO. 5)

The provisions of Section 2, "Clearing and Grubbing", and Section 21, "Tree Trimming and Removal", of the Technical Provisions of the Standard Specifications shall apply in their entirety except as modified or supplemented herein.

SP16-01 GENERAL

Clearing and grubbing work under this section shall consist of removing and disposing of existing trash; debris; rocks; vegetation; leaves; roots; tree remains; and other rubbish from the work area, and trimming existing trees, shrubs, ground cover and roots, and disposing of all resulting materials.

The cleared areas shall be approved by the Engineer prior to performing crack fill, pavement repair, slurry seal, micro-surfacing or chip seal work.

Not all areas requiring clearing are specifically noted on the plans; however, clearing shall be sufficient to allow unobstructed access for all Contractor's equipment and clear view of all street signs. **Vegetation, debris and trash shall be cleared to a point one foot behind the existing face of curb or edge of pavement and to achieve a vertical clearance of 14'6" within the work limits. See additional provisions regarding tree trimming below.** All existing vegetation, outside the areas to be cleared and grubbed, shall be protected from injury or damage resulting from the Contractor's operations.

SP16-02 TREE TRIMMING AND TREE PROTECTION

Tree and shrub trimming shall conform to the requirements of Section 21, "Tree Trimming and Removal", of the Technical Provisions of the Standard Specifications.

This project includes work on streets with mature trees adjacent to the work area. In some locations, the tree canopy may extend over the roadway or work area. It is the responsibility of the Contractor to conduct his/her operations around said tree canopy such that the work is accomplished without damage to trees. The Contractor shall inspect and determine required clearance for all equipment and vehicles and perform pruning as necessary with the approval of the Engineer prior to the start of work. The Contractor may, with the Engineer's approval, trim trees in order to better facilitate his/her construction operations. No trimming of trees is allowed without specific written permission from the Engineer. Any trimming that may be required must be approved at least two (2) working days in advance.

When tree trimming is permitted by the Engineer for the Contractor's convenience, tree trimming shall be performed under the direction of a certified arborist and in accordance with *Pruning Standards* published by the Western Chapter of the International Society of Arboriculture. The Certified Arborist shall be provided by the Contractor and shall be approved in advance by the Engineer. All trimming shall be done in the presence of the Engineer.

Special Provisions

SP16-04 PROTECTION OF EXISTING TREES

Contractor shall make all personnel on site aware of the tree protection requirements. Failure of any worker to observe these requirements or to operate equipment with sufficient care to avoid damaging trees is grounds for removal of said worker from the project by the Engineer.

The Contractor shall use extreme care when excavation operations occur in the proximity of trees. At no time shall the Contractor strike trees with excavation equipment. Trees less than 6 inches in diameter that are damaged by the Contractor shall be mitigated by the replacement of said tree in kind with regards to size and species. Trees greater than 6 inches in diameter shall be examined by a Certified Arborist and a report provided to the Engineer indicating measures that can be taken to mitigate the damage to the tree. In the event the tree must be removed the Contractor shall replace the tree at a 3 to 1 ratio. The trees shall be planted in locations determined by the Engineer. All associated reports, removals and mitigation work shall be performed at no cost to the City.

SP16-05 MEASUREMENT AND PAYMENT

The contract lump sum price paid for “**Clearing & Grubbing, Tree Trimming, and Tree Protection**” shall include full compensation for furnishing all labor, supervision, materials, tools, equipment and incidentals, and for doing all the work involved in clearing and grubbing and tree trimming, and tree protection including, but not limited to, the removal and disposal of all existing trash, debris, rocks, shrubs and vegetation; trimming of shrubs, trees of diameters less than 6” and other vegetation; tree protection, and all other work as shown on the Plans, as specified in the Standard Specifications and these Special Provisions and as directed by the Engineer and no additional compensation shall be allowed therefor.

SPECIAL PROVISIONS SECTION SP-17

EXISTING HIGHWAY FACILITIES

(BID ITEM NO. 14)

SP17-01 GENERAL

The work performed in connection with various existing highway facilities shall conform to the provisions of Section 7, "Existing Utilities" of the General Provisions, Section 2, "Clearing and Grubbing", and Section 22, "Protection and Restoration of Existing Improvements", of the Technical Provisions of the Standard Specifications, and Section 15, "Existing Highway Facilities", of the State Specifications, these Special Provisions, and as directed by the Engineer.

The Contractor shall fully document pre-construction conditions at all points around the work area. This documentation shall consist of notes, still photographs, and video. Special effort shall be made to document the existing conditions at all buildings and private improvements not to be disturbed.

The Contractor shall reference, preserve and protect all manholes, valve covers, survey monuments and recorded survey points including but not limited to railroad spikes, iron pipes, and metal pins prior to construction. Upon completion of the work, all manholes, survey monuments and water valve covers shall be thoroughly cleaned of any construction debris resulting from the Contractor's operations.

All existing pavement markers, thermoplastic stripes, and legends within the chip seal, slurry seal, and micro-surfacing limits shall be completely removed immediately prior to sealing the roadway.

SP17-02 STREET SWEEPING

At the end of every work day, construction debris of any kind shall be swept from all surfaces within the areas affected by the Contractor's operations. Failure to conform to these provisions shall be ground for suspension of work per Section 8-3 of the General Provisions.

SP17-03 REFERENCING EXISTING FACILITIES

Work by the Contractor shall include locating existing facilities and referencing, and setting sufficient marks prior to any excavation to enable their subsequent retrieval by the Contractor or utility company. The Contractor shall reference and set marks for all survey points, storm drain manholes, Central Contra Costa Sanitary District (CCCSD) sewer manholes, rodding inlets, and cleanouts, East Bay Municipal Utility District (EBMUD) water valves, and Pacific Gas and Electric (PG&E) gas valves. The Contractor shall submit a plan to the Engineer at least forty-eight (48) hours in advance chip seal or slurry seal operations showing all reference points and offset distances set for each storm drain manhole, and utility facilities.

All reference points made by the Contractor for CCCSD, PG&E, EBMUD and telephone facilities shall be protected and remain undisturbed until project completion.

SP17-04 REMOVALS

Existing highway facilities to be removed under this section and as shown on the Plans shall include, but not be

Special Provisions

limited to, removing existing concrete curb and gutter, and existing traffic striping and markers. These items shall be removed and disposed of in accordance with Section 6-16, "Disposal Outside Project Limits", of the General Provisions of the Standard Specifications.

Concrete curb and gutter to be removed shall be sawcut as marked by the Engineer in the field. Curb and gutter removal shall include removing enough existing native or base material to allow for placement of the specified thickness of new base material.

For the purpose of concrete forming and conform paving, the removal of a one-foot wide and six-inch deep strip of asphalt adjacent to concrete designated to be removed shall be included in the costs associated with the removal of the concrete.

Whenever existing curb and gutter are removed, the Contractor shall place Type II barricades with flashing lights at the location of the removed facility. Spacing for Type II barricades shall be no greater than ten (10) feet on center for curb and gutter. Caution tape shall be attached to barricades if needed to delineate the area.

Markers, stripes, or legends which are removed shall be replaced with temporary markers, stripes, and legends prior to opening the roadway to vehicular or pedestrian traffic. Pavement delineation removal shall conform to the provisions of Section 15-4, "Removal of Existing and temporary Stripes and Pavement Markings," of the Technical Provisions of the Standard Specifications. Removal by sandblasting shall not be allowed.

Attention is directed to Section SP-26, "Temporary Pavement Delineation", of these Special Provisions.

SP17-05 MONUMENTS AND PROPERTY CORNERS

Existing survey monuments shall be preserved, referenced or replaced pursuant to the requirements of State of California Streets and Highways Code Sections 732.5, 1492.5, and 1810.5 and Business and Professions Code Section 8771 and the following:

The Contractor shall not disturb permanent survey monument or bench mark. The Contractor shall bear the expense of replacing any monument or benchmark that is disturbed without permission. Replacement shall be done only with the direction of and in the presence of the Engineer.

Should the Contractor during the course of construction encounter a survey monument or benchmark not shown on the plans, Contractor shall promptly notify the Engineer so that the monument or bench mark may be referenced accordingly.

SP17-06 MEASUREMENT AND PAYMENT

Full compensation for locating and marking utilities and the preparation of utility reference point plans shall be considered as included in the contract price paid for various contract items of work and no additional compensation shall be allowed therefor.

The contract lump sum price paid for "**Remove Existing Pavement Markers and Thermoplastic Stripes and Legends**" shall be considered as full compensation for furnishing all labor, materials, tools, equipment and incidentals necessary to remove and dispose of pavement markers, stripes and legends, as specified in the Standard Specifications, the State Specifications and these Special Provisions, and as directed by the Engineer, and no additional compensation shall be allowed therefore.

Special Provisions

Compensation for the removal of concrete curb and gutter shall be as included in the contract price paid for “Remove and Replace Concrete Curb and Gutter” as specified elsewhere in these Special Provisions.

SPECIAL PROVISIONS SECTION SP-18

AGGREGATE BASE
(NO BID ITEM)

The provisions of Section 8, "Aggregate Base", of the Technical Provisions of the Standard Specifications shall apply in their entirety except as modified or supplemented herein.

SP18-01 GENERAL

This work shall consist of furnishing and placing Class 2 Aggregate Base to the lines, grades and compaction requirements shown on the Plans and specified in these Special Provisions. The Contractor's attention is directed to Section SP12-5, "Hauling Equipment Size and Weight Limitations", of these Special Provisions.

SP18-02 MATERIALS

Class 2 Aggregate Base shall conform to the 3/4-inch maximum grading and quality requirements as specified in Section 8, "Aggregate Base", of the Technical Provisions of the Standard Specifications.

SP18-03 MEASUREMENT AND PAYMENT

There shall be no separate measurement or payment for furnishing and placing the aggregate base used in the construction of all other items of work shown on the bid proposal, and full compensation shall be considered as included in the contract unit prices paid for those bid items requiring aggregate base, and no additional compensation shall be allowed therefor.

SPECIAL PROVISIONS SECTION SP-19

PAVEMENT REPAIR AND SKIN PATCH

(BID ITEM NO. 9 AND 10)

SP19-01 GENERAL

The provisions of Section 5, "Street Failed Area Repair" of the Technical Provisions of the Standard Specifications shall apply in their entirety except as modified or supplemented herein.

Asphalt Concrete requirements shall be as described in Section 9, "Asphalt Concrete" of the Technical Provisions of the Standard Specifications and these Special Provisions.

Asphalt Concrete shall be placed in accordance with section 9-5 "Placement" of Technical Provisions of the Standard Specification. Type I, ½" maximum sized aggregate (MSA) asphalt mix shall be used for all pavement repairs and skin patches.

Pavement repairs shall be made using two equal lifts of asphalt. The second lift of asphalt shall not be placed until the underlying layer is 160° F or less, unless otherwise directed by the Engineer. Failure to meet these requirements shall be cause for rejection of the work.

An asphalt concrete mix design shall be submitted with the Certificates of Compliance described in Section 9-8, "Certificates of Compliance" of the Technical Provisions of the Standard Specifications.

The Contractor shall not perform pavement repair or skin patch operations when the weather is rainy, foggy or when the atmospheric temperature is below 50° F. It shall be the Contractor's responsibility, based on weather predictions, to schedule pavement repair and skin patch operations to avoid placing asphalt in the rain or fog. If the day's operations are canceled because of predicted rain or fog, a non-working day will be allowed. Asphalt concrete shall not be placed on any surface which contains ponded water or excessive moisture in the opinion of the Engineer. If paving operations are in progress and rain or fog forces a stoppage of work, loaded trucks in transit shall return to the plant and no compensation shall be allowed for unused materials.

The Contractor shall furnish and use canvas tarpaulins to cover all loads of asphalt concrete from the time that the mixture is loaded until it is discharged from the delivery vehicle. Failure to cover asphalt loads shall be grounds for rejection of the load.

Batch data and load slips shall be presented to the Engineer as asphalt is delivered to the project site to allow verification of materials and use. Failure to do so may result in non-payment for disputed loads.

Paint markings delineating the approximate size and location of the pavement repair and skin patch areas have been made in the field on all streets. The Contractor shall submit a request for any re-marking in writing five (5) working days in advance of beginning pavement repair and skin patch work. Actual quantities may be greater or less than the quantities shown on the bid schedule.

Prior to placing "Skin Patch", the area shall be swept clean of loose materials and shall be crack sealed in accordance with Section SP-20, "Crack Seal" of these Special Provisions.

Special Provisions

In areas designated for “Pavement Repair”, as marked in the field by the Engineer, the existing base and bituminous surfacing shall be removed by cold planing, or sawcutting and excavating to the depth shown on the contract plans. Pavement repair areas shall be a minimum of 4-feet in width. Pavement removed beyond the limits designated by the Engineer shall be considered to be for the Contractor’s convenience and shall be at no additional expense to the City. The excavated area shall be backfilled with asphalt concrete, compacted, and finished as shown on the Plans and as specified in these Special Provisions.

The Contractor’s attention is directed to Section 6-16, “Disposal Outside Project limits,” of the General Provisions of the Standard Specifications.

All excavations for base failure repairs and pavement repairs shall be backfilled to the existing pavement level in the same working period during which the excavation is performed, and prior to opening the full roadway to public traffic. Lane closures shall remain in full force until such time as the repair area has been finished to the existing pavement level.

If necessary, due to unforeseen occurrences, excavations shall be temporarily filled to the existing pavement level at the end of the working period, and subsequently re-excavated at the Contractor’s expense. Temporarily filled excavations shall have a minimum two-inch thick asphalt concrete surface, or covered with a steel trench plate held in place with temporary asphalt concrete ramps not less than 10” long all along the plate edges on all sides.

The finished pavement surface shall be smooth and free of cracks, shoving, displacement, and segregation of coarse and fine materials. Paving shall be to a clean neat joint with existing grade. Paving with evidence of poor workmanship such as rock pockets, ripples, voids, or out of tolerance as defined by contract specifications, shall be removed.

SP19-02 MEASUREMENT AND PAYMENT

The contract unit price paid per square foot for “**Pavement Repair**” and “**Skin Patch**” shall include full compensation for furnishing all labor, supervision, materials, tools, equipment and incidentals and for doing all the work involved including, but not limited to, cold planing, sawcutting, excavating, loading, off hauling, disposing of materials, subgrade preparation and compaction, asphalt emulsion, and furnishing, placing, spreading, and compacting the asphalt concrete to the specified depth and all other work as shown on the Plans, as specified in the Standard Specifications, the State Specifications and these Special Provisions, and as directed by the Engineer and no additional compensation shall be allowed therefor.

SPECIAL PROVISIONS SECTION SP-20

CRACK SEALING (BID ITEM NO. 11)

SP20-01 GENERAL

The provisions of Section 12-2, "Crack Fill Repairs," of the Technical Provisions of the Standard Specifications shall apply in their entirety except as modified or supplemented herein.

Crack sealing work shall include routing, cleaning, and sealing pavement cracks one-eighth-inch (1/8") and greater in width as directed by the Engineer. Growing vegetation shall be removed from cracks in pavement and at the interface of pavement and gutter and swept clean from the street surface prior to sealing cracks, and disposed of per Section 6-16 of the General Provisions. The Contractor may blow the cracks clean of loose materials with a high pressure air nozzle (90 psi or greater and free of oil). All streets shown to be crack sealed, slurry sealed, micro-surfaced or cape sealed shall be crack filled. **Streets to be chip sealed only will not require crack sealing. However, the cracks must be cleaned of debris and vegetation.**

SP20-02 MATERIALS

The Contractor shall submit certificates from suppliers stating compliance of materials with the requirements of this section.

The modified asphalt materials shall be furnished premixed in containers with an inside liner of polyethylene. Packaged material shall not exceed 60 lbs. in weight. Storage and heating instructions and cautions shall be supplied by the vendor with each shipment.

The materials shall be capable of being melted and applied to cracks and joints at temperatures below 400°F. When heated, it shall readily penetrate cracks one-eighth inch (1/8") wide or larger.

Crack sealing shall be performed after pavement repairs are completed and prior to chip or slurry sealing.

The asphalt-rubber shall be heated to a minimum temperature of 325° F, but not greater than 390° F, or as specified by the manufacturer and as approved by the Engineer. The material shall be held in the mixing tank at application temperature until very little separation of the rubber and asphalt occurs when a bead of sealant material is placed on the pavement. Sealant material may be added to the mix as long as the minimum temperature of 325 ° F is maintained.

Cracks shall be sealed from the bottom up. Sealant material shall be applied so it is flush with the pavement surface. In some cases multiple passes and or sand backing material may be required to fully fill the cracks with sealant. Sealant material must not be higher than the adjacent surface.

To prevent tracking and damage to vehicles crack sealant shall be allowed to cool sufficiently or sand shall be applied to the crack sealant material prior to releasing the road to traffic.

Special Provisions

SP20-03 MEASUREMENT AND PAYMENT

The contract lump sum price paid for “**Crack Seal**” shall be considered as full compensation for furnishing all labor, materials, tools, equipment and incidentals and for doing all the work involved in crack sealing, including, but not limited to, routing, blowing, crack filling, sanding and clean-up, and all other work, as shown on the Plans, as specified in the Standard Specifications and these Special Provisions, and as directed by the Engineer and no additional compensation shall be allowed therefore.

SPECIAL PROVISIONS SECTION SP-21

SLURRY SEAL
(BID ITEM NO. 12)

SP21-01 GENERAL

The provisions of Section 10, “Bituminous Seal Coats,” of the Technical Provisions of the Standard Specifications shall apply in their entirety except as modified or supplemented herein.

SP21-02 MATERIALS

The materials for slurry seal immediately prior to mixing shall conform to the following requirements:

SP21-02.1 LATEX MODIFIED ASPHALT EMULSION

Latex emulsified asphalt shall be a quickset PMCQS1h type, shall be a homogeneous throughout and show no separation after thorough mixing, shall break and set on the aggregate within five (5) minutes and shall be ready for cross-traffic within fifteen (15) to forty five (45) minutes. The latex asphalt emulsion, upon standing undisturbed for a period of twenty-four (24) hours, shall show no white or milky colored substance on its surface and conform to the requirements in the table below;

<u>TEST ON EMULSION</u>	<u>METHOD OF TEST</u>	<u>REQUIREMENTS</u>
Viscosity, SSF, @ 77° F., sec	ASTM D244	15-100
PH	ASTM D244	2 +/-1
Distillation Residue %, Minimum	ASTM D244	60

<u>TESTS ON RESIDUE FROM DISTILLATION TESTS</u>	<u>METHOD OF TEST</u>	<u>REQUIREMENTS</u>
Penetration, 77°F, 100g, 5s	ASTM D5	40-80
Softening Point (Ring & Ball), °F.	ASTM D36	130+
Ductility, 77° F, 5CM/Min, Minimum	ASTM D113	25
Fraass-Breaking Point (°C)	DIN 52012	-18 min.

SP21-02.2 AGGREGATE

Aggregate shall consist of sound, durable, crushed stone or crushed gravel and approved mineral filler. The material shall be free from vegetable matter and other deleterious substances. Aggregate shall be 100% crushed with no rounded particles, volcanic in origin and black in color, as supplied by George Reed, Table Mountain Plant, Sonora, CA, or approved equal. **The use of gray or light colored aggregate shall not be allowed.** The

Special Provisions

Contractor shall submit aggregate samples, for approval at least ten (10) days prior to starting slurry seal operations. The percentage composition by weight of the aggregate shall conform to the following grading:

PERCENTAGE PASSING

<u>SIEVE SIZES</u>		<u>TYPE II</u>
3/8"	(9.5mm)	100
No. 4	(4.75 mm)	94-100
No. 8	(2.36 mm)	65-90
No. 16	(1.18 mm)	40-70
No. 30	(600 um)	25-50
No. 200	(75 um)	5-15

The aggregate shall also conform to the following quality requirement:

<u>TEST ON AGGREGATE</u>	<u>METHOD OF TEST</u>	<u>REQUIREMENTS</u>
Sand Equivalent	California Method 217	70 min.
Durability Index	California Method 229	75 min.
Percentage of Crushed Particles (Min) ¹	California Method 205	100%
Los Angeles Rattler Loss at 500 Rev. (Max) ²	California Method 211	35%

Notes: 1. CT205, Section D, is amended to read: "Any particle having 2 or more freshly, mechanically fractured faces shall be considered a crushed particle." 2. Los Angeles Rattler shall be performed on the parent aggregate before crushing.

SP21-02.3 MINERAL FILLER

Mineral filler shall be added to the aggregate at the rate of 0.0 to 2.5 percent by weight of the dry aggregate, if required by the mix design.

The mineral filler shall be either Portland Cement or other approved mineral fillers, if required. Portland Cement, if used, shall be commercially available Type I-II and shall be free of lumps and clods.

SP21-02.4 WATER

Water shall be free of harmful, soluble salts and shall be of such quality that the asphalt shall not separate from the emulsion before the emulsion mix is in place in the work.

SP21-02.5 POLYMER LATEX

Styrene Butadiene Rubber latex polymer shall be added to the water/soap phase by injection prior to the mill manufacture of the emulsified asphalt by the emulsion producer. The polymer shall be BASF NX 1118 or approved equal. The amount of polymer solids shall be between 3 and 4 percent of the asphalt residual content and shall be certified by the emulsion producer on each load of emulsion delivered to the job site. No post of

Special Provisions

field addition of polymer will be allowed. The Contractor shall submit to the Engineer for approval a laboratory report of tests indicating the polymer conforms to the following requirements:

<u>TEST</u>	<u>REQUIREMENT</u>
Total solids, min, %	60
Bound Styrene %	24-60
PH at 25 ° C	4.2-5.2
Brookfield viscosity RVT	1000-4000
Residual Monomer %	0.08 max

SP21-03 MIX DESIGN

At least 7 working day before slurry seal placement commences, the Contractor shall submit to the Engineer for approval a laboratory report of tests and proposed mix design covering the specific materials to be used on the project. **The percentage of asphalt emulsion proposed in the mix design shall be 12 to 18 percent.** The job mix design shall include a recommended application rate of slurry to sit the job site conditions.

The tests and mix design shall be performed by a laboratory capable of performing the applicable International Slurry Seal Association (ISSA) tests. The proposed slurry seal mixture shall conform to the requirements specified when tested in accordance with the following tests:

<u>TEST</u>	<u>ISSA TEST METHOD</u>	<u>REQUIREMENT</u>
Slurry seal consistency, cm	TB106	2-3 cm
Wet Stripping	TB114	Pass (90% Min)
Compatibility	T115	Pass(a)
Cohesion Test, kg-cm within 1 hour	T139	20 min. (b)
Wet Track Abrasion, g/sqft	T100	75 max.

(a) Mixing test must pass at the maximum expected air temperature at the project side during application (90°F)

(b) Using project source aggregate asphalt emulsion and set-control agents if used

The laboratory report shall be signed by the laboratory that performed the tests and mix design and shall show the results of the tests on individual materials, comparing the test results to those required by the specifications. The report shall clearly show the proportions of aggregate, filler (as determined from the tests, minimum and maximum), water (minimum and maximum), asphalt solids content based on the dry weight of aggregate and set-control agent usage. Previous laboratory reports covering the same materials may be accepted provided they are made during the same calendar year.

Special Provisions

SP21-04 PROPORTIONING

The Slurry Seal mixture shall be proportioned by the operation of a single start/stop switch or lever which automatically sequences the introduction of aggregate, emulsified asphalt, admixtures, if used, and water to the pug mill.

Calibrated flow meters shall be provided to measure both the addition of water and liquid additives to the pug mill. If necessary for workability, a retarding agent, that will not adversely affect the seal, may be used.

Water, and retarder if used, shall be added to ensure proper workability and (a) permit uncontrolled traffic on the slurry seal no more than three (3) hours after placement without the occurrence of bleeding, raveling, separation or other distress; and (b) prevent development of bleeding, raveling, separation or other distress within fifteen (15) days after placing the slurry seal.

SP21-05 MIXING AND SPREADING EQUIPMENT

The Slurry Seal material shall be mixed in a self-propelled mixing machine equipped with a continuous flow pug mill, capable of accurately delivering and automatically proportioning the aggregate, polymer modified asphalt emulsion, mineral filler, water, and admixtures to a double shafted, multi-blade pug mill mixer capable of minimum speeds of 200 revolutions per minute.

A minimum of two operation mixing machines of 12 cubic yard capacity, or larger, shall be maintained on the project. The mixed slurry seal material retention time in the pug mill shall be less than three seconds. No retention of mixed slurry seal material shall be allowed within the pug mill by gate shut-off or other mechanical means. Any machines with pug mill retention or shut-off gates shall have them removed prior to being used on this project. The mixing machine shall have sufficient storage capacity of aggregate, emulsified asphalt, and water to maintain an adequate supply to the proportioning controls.

The mixing machine shall be equipped with hydraulic controls for proportioning the material by volume to the mix. Each material control device shall be calibrated, properly marked, preset and lockable at the direction of the Engineer. The mixing machine shall be equipped with a water pressure system and nozzle type spray bars to provide a water spray immediately ahead of the spreader box.

The mixing machine shall be equipped with an approved fines feeder that provides a uniform, positive, accurately metered, predetermined amount of the mineral filler at the same time and location that the aggregate is fed.

Each mixing unit to be used in the performance of the work shall be calibrated in the presence of the Engineer prior to the start of the project. Previous calibration documentation covering the exact materials to be used will be acceptable, provided that no more than 60 calendar days have lapsed. The documentation shall include an individual calibration of each material at various settings that can be related to the machine metering devices. Any component replacement affecting material proportioning requires that the machine be recalibrated. No machine will be allowed to work on the project until the calibration has been completed and/or accepted.

The spreader shall be capable of spreading a traffic lane width and shall have strips of flexible rubber belting or similar material on each side of the spreader box and in contact with the pavement to prevent loss of slurry from the box. The box shall have baffles, or other suitable devices, to insure uniform application on super-elevated sections and shoulder slopes. Spreader boxes shall be maintained in such a manner as to prevent chatter (wash boarding) or other surface defects that will affect the aesthetic value of the finished slurry seal mat.

Special Provisions

The rear flexible strike-off blade shall make close contact with the pavement and shall be capable of being adjusted to the various crown shapes so as to apply a uniform slurry seal.

Slurry mixture, to be spread in areas inaccessible to the controlled spreader box, may be spread by other approved methods.

Slurry seal spreader box shall be wrapped in plastic or other suitable material to prevent slurry materials being dropped on the haul routes while in transit to and from the stockpile area or from one project street to another. Failure to comply with this specification shall be grounds for suspension of work until corrective measures are implemented.

SP21-06 SURFACE PREPARATION

The surface to receive slurry seal shall be prepared in accordance with the requirements specified for preparing surfaces to receive asphaltic emulsion as specified in Section 10-1.8, "Surface Preparation", of the Standard Specifications and these Special Provisions.

Pavement must be completely dry prior to the application of slurry seal.

Special care shall be taken to clean the pavement before the slurry seal application. Immediately prior to the application of the slurry seal the surface to receive the slurry seal shall be cleaned by vacuum sweeping, flushing or other means necessary to remove all vegetation, loose particles of paving, all dirt, and all other extraneous material. Pavements impregnated with grease, oil, or fuel shall be thoroughly scrubbed with water and an approved detergent and then flushed and swept clean. Wash water shall be vacuumed up and disposed of and shall not be permitted to enter the storm drain system. Contractor shall be responsible for sweeping the streets until sufficiently cleaned to the satisfaction of the Engineer. Streets shall be swept from face of curb to face of curb. Pavement missed by or inaccessible to broom sweepers shall be swept manually or by other methods approved by the Engineer.

All vegetation and debris removed from the roadway surface shall become the property of the Contractor and shall be disposed of in accordance with Section 6-16 "Disposal Outside Project Limits" of the General Provisions of the Standard Specifications.

All existing temporary and permanent pavement markers and temporary delineation shall be removed in accordance with Section SP17, "Existing Highway Facilities" of these Special Provisions.

All surface metal utility covers (including survey monuments) shall be protected by thoroughly covering the surface with an appropriate adhesive and paper or plastic. No adhesive material shall be permitted to cover, seal or fill the joint between the frame and cover of the structure. Covers are to be uncovered and cleaned of chip seal material by the end of the same work day.

SP21-07 PLACING

Slurry seal shall be placed a minimum of seven (7) calendar days after the completion of the chip seal on streets that are designated for cape seal on the project plans or in these special provisions.

Special Provisions

The slurry seal shall not be placed during unsuitable weather or if either the pavement or the air temperature is below 55° F (13° C). The mixture shall also not be applied if high relative humidity prolongs the curing beyond a reasonable time.

Slurry seal shall be spread at the rate of 14-18 lbs. of dry aggregate per square yard.

The slurry seal mixture shall fill all minor cracks, depressions or low areas and leave a uniform surface free from ruts, humps, depressions, or irregularities. Any ridges, indentations, or other objectionable marks left in the surface shall be eliminated by rolling or other means. The mixture shall be uniform and homogeneous after spreading on the existing surface and shall not show separation of the emulsion and aggregate after setting.

Construction joints shall be neat in appearance and shall be tapered or feathered to conform to the existing surfacing. All excess materials shall be removed from surfaces upon completion of each run.

Following application of the slurry seal, the Contractor shall protect the slurry seal from any traffic that may cause damage to the finished surface or result in tracking of the slurry material until such time as the material has sufficiently cured.

A sand blotter shall be spread at selected driveways, intersections and where required by the Engineer to accommodate pedestrian or vehicular traffic until slurry cures. The sand used shall be Lone Star Lupis Luster dried sand grades, #213, 2-16, 16, 120 or an approved equal. Substitutes must be submitted for approval prior to use. Sand blotters at intersections shall be swept within fourteen (14) hours of placement or sooner if directed by the Engineer. If the City has the sand removed, the Contractor will be charged the cost of the removal and disposal.

Any slurry seal material that is spilled onto concrete gutter surfaces shall be removed on the same day the material was placed. Concrete surfaces that are stained due to spilled slurry materials shall be cleaned to the satisfaction of the Engineer.

Seal cost that shows continuous or excessive raveling of aggregate shall be considered defective and rejected by the Engineer.

SP21-08 ROLLING

The surface of the street or parking lot shall be rolled by a self-propelled, 10-ton (maximum) pneumatic tire roller equipped with a water spray system. All tires shall be inflated per manufacturer's specifications. Rolling shall not start until the seal coat has cured sufficiently to avoid damage by the roller. Areas which require rolling shall receive a minimum of two (2) full coverage passes.

SP21-09 STREET SWEEPING

Once the slurry seal has cured and is open to traffic, any excessive raveling of the aggregate from the seal coat shall be swept up by the Contractor. Sweeping shall continue until such time when the raveling ceases. Failure to provide adequate sweeping shall result in the City performing said work at the Contractor's sole expense, which shall be deducted from any monies due to the Contractor. Sweeping by City forces shall not relieve the Contractor of any liability arising from his failure to comply with these Special Provisions.

Special Provisions

SP21-10 MEASUREMENT AND PAYMENT

The contract unit price paid per square yard “**Slurry Seal**,” shall be considered as full compensation for furnishing all labor, materials, tools, equipment and incidentals and for doing all the work involved in slurry sealing, including but not limited to; site preparation, cleanup, protecting utility and manhole covers, applying slurry seal, rolling, protection during curing, street sweeping and all other incidental work required to complete the work as shown and specified.

SPECIAL PROVISIONS SECTION SP-22

MICRO-SURFACING
(BID ITEM NO. 12A)

SP22-01 GENERAL

The provisions of Section 10, "Bituminous Seal Coats," of the Technical Provisions of the Standard Specifications shall apply in their entirety except as modified or supplemented herein.

SP22-01 MATERIALS

The materials for micro-surfacing shall conform to the following requirements:

SP22-01.1 MICRO-SURFACING EMULSION

Microsurfacing Emulsion (MSE) shall be homogenous and shall conform to the provisions of these special provisions. The polymer shall be milled or blended into the asphalt or blended into the emulsifier solution prior to the emulsification process.

The MSE shall conform to the following requirements when tested in conformance with the following test methods:

POLYMER MODIFIED, CATIONIC MICROSURFACING EMULSION (MSE)

<u>SPECIFICATION DESIGNATION</u>	<u>METHOD OF TEST</u>	<u>REQUIREMENTS</u>
Viscosity, SSF, @ 77° F, sec	AASHTO T 59	15-90 seconds
Sieve, Max	AASHTO T 59	0.30 percent
Settlement, 5 days, max.	ASTM D244	5 percent
Storage Stability, 1 day, max.	AASHTO T 59	1 percent
Residue by Evaporation, min.	California Test 331	62 percent

<u>TESTS ON EMULSIFIED ASPHALT RESIDUE</u>	<u>METHOD OF TEST</u>	<u>REQUIREMENTS</u>
Penetration, 77°F, 100g, 5s, 0.1mm	AASHTO T 51	40-90
Softening Point (Ring-and Ball Apparatus), Min	AASHTO T53	135°F (57°C)

SP22-01.2 AGGREGATE

Aggregate shall consist of sound, durable, crushed stone or crushed gravel and approved mineral filler. The material shall be free from vegetable matter and other deleterious substances. Aggregate shall be 100% crushed with no rounded particles, volcanic in origin and black in color, as supplied by George Reed, Table Mountain

Special Provisions

Plant, Sonora, CA, or approved equal. **The use of gray or light colored aggregate will not be allowed.** The Contractor shall submit aggregate samples, for approval at least ten (10) days prior to starting micro-surfacing operations.

The aggregate, prior to the addition of emulsion shall conform to the requirements of this section. If aggregates are blended each component aggregate shall meet the sand equivalency and abrasion resistance and shall be 100% crushed as tested in accordance with California Test 205. The definition of a crushed particle in California Test 205 Section D, is amended to read: “Any particle having 2 or more fresh mechanically fractured faces shall be considered a crushed particle.”

The percentage composition by weight of the aggregate (including mineral filler) shall conform to the following grading requirements when tested in conformance with California Test 202:

PERCENTAGE PASSING

<u>SIEVE SIZES</u>	<u>TYPE II</u>
3/8” (9.5mm)	100
No. 4 (4.75 mm)	94-100
No. 8 (2.36 mm)	65-90
No. 16 (1.18 mm)	40-70
No. 30 (600 um)	25-50
No. 200 (75 um)	5-15

The aggregate (excluding mineral filler) shall also conform to the following quality requirement:

<u>TEST ON AGGREGATE</u>	<u>METHOD OF TEST</u>	<u>REQUIREMENTS</u>
Sand Equivalent	California Method 217	70 min.
Durability Index	California Method 229	75 min.
Percentage of Crushed Particles (Min) ¹	California Method 205	100%
Los Angeles Rattler Loss at 500 Rev. (Max) ²	California Method 211	35%

Notes: 1. CT205, Section D, is amended to read: “Any particle having 2 or more freshly, mechanically fractured faces shall be considered a crushed particle.” 2. Los Angeles Rattler shall be performed on the parent aggregate before crushing.

SP22-01.3 MINERAL FILLER

The mineral filler shall be either Portland Cement or hydrated lime that is free of lumps. Portland cement shall be either Type I, Type II, or Type III or combination thereof. The type of mineral filler shall be determined by the Contractor based on laboratory mix designs. The mineral filler will be considered part of the aggregate gradation requirement.

Special Provisions

SP22-01.4 WATER

Water shall be of such quality that the asphalt will not separate from the MSE before the micro-surfacing is placed on the pavement. If necessary for workability, a set-control agent that will not adversely affect the micro-surfacing product may be used.

SP22-02 MIX DESIGN

At least 7 working days before the micro-surfacing placement commences, the Contractor shall submit for approval of the Engineer a laboratory report of tests and a proposed mix design covering the specific materials proposed for use on the project.

The percentages of each individual material proposed in the mix design shall be shown in the laboratory report. Individual materials shall be within the following limits:

Residual Asphalt	5.5% to 10.5% by dry weight of aggregate
Polymer Solids	3% Minimum based on bitumen weight content
Mineral Filler	0% to 3% by dry weight of aggregate
Additive	As needed
Water	As needed

Adjustments may be required during construction based field conditions.

The mix design and aggregate tests shall be performed by a laboratory capable of performing the applicable International Slurry Surfacing Association (ISSA) tests. The proposed micro-surfacing mixture shall conform to the specified requirements when tested in conformance with the following tests:

<u>TEST</u>	<u>ISSA TEST METHOD</u>	<u>REQUIREMENT</u>
Wet Cohesion		
@30 Minute (Set)(Min.)	TB139	12 kg-cm
@60 Minute (Traffic)(Min.)		20 kg-cm
Excess Asphalt (Max)	TB109	540 g/m ²
Wet Stripping (Min.)	TB114	90%
Wet Track Abrasion 6-day Soak Loss (Max)	TB100	810 g/m ²
Displacement		
Lateral (Max)	T147A	5%
Specified Gravity After 1000 Cycles of 125 lbs (56.8 kg)(Max)		2.10
Classification Compatibility	TB144	11 Grade Points Minimum

Special Provisions

(AAA,BAA)

Mix Time @77°F(25°C)

TB113

Controllable to 120 Seconds

TB=Technical Bulletin

The laboratory that performed the tests and designed the mixture shall sign the laboratory report. The report shall show the results of the tests on individual materials and shall compare their values to those required by these special provisions. The report shall clearly show the proportions of aggregate, filler (minimum and maximum), water (minimum and maximum), set control additive, and MSE solids content (minimum and maximum) based on the dry mass of aggregate. The laboratory shall report the quantitative effects of moisture content on the unit mass of the aggregate (bulking effect) in conformance with the requirements of ASTM Designation C 29M. Previous laboratory reports covering the same materials may be accepted provided the material test reports were completed within the previous 12 months. The mix design shall further show the recommended changes in mineral filler, water, and additive proportions for high temperature weather conditions by reporting proportions of materials required for 60 seconds of mix time with materials heated to 100 °F (38°C). This 100 °F (38°C) mixing report will not be required for projects requiring nighttime application.

The component materials used in the mix design shall be representative of the micro-surfacing materials proposed by the Contractor for use on the project.

Once the mix design is approved by the Engineer, no substitution of other material will be permitted unless the materials proposed for substitution are first tested and a laboratory report is submitted for the substituted design in conformance with the provisions of these special provisions. Substituted materials shall not be used until the mix design for those materials has been approved by the Engineer.

The completed mixture, after addition of water and set control agent, if used, shall be such that the micro-surfacing mixture has proper workability. At the expiration of the road closure hours, in conformance with the provisions in Section SP14, "Traffic Control" of these special provisions, the micro-surfacing mixture shall be sufficiently cured to support unrestricted traffic.

SP22-03 PROPORTIONING

Aggregate, mineral filler, MSE, water, and additives, including the set-control agent, if used, shall be proportioned by volume utilizing the mix design approved by the Engineer. If more than one kind of aggregate is used, the correct amount of each kind of aggregate to produce the required grading shall be proportioned separately, prior to adding the other materials of the mixture, in a manner that will result in a uniform and homogeneous blend.

The aggregate shall be proportioned using a belt feeder operated with an adjustable cutoff gate. The height of the gate opening shall be determinable. The MSE shall be proportioned by a positive displacement pump. Variable rate emulsion pumps, if used, shall be calibrated and sealed in the pump's calibrated condition in conformance with California Test 109 prior to usage.

The delivery rate of aggregate and MSE per revolution of the aggregate feeder shall be calibrated at the appropriate gate settings for each mixer-spreader truck used on the project in conformance with California Test 109 and in conformance with the provisions of these special provisions.

Special Provisions

The aggregate belt feeder shall deliver aggregate to the pugmill with such volumetric consistency that the deviation for any individual aggregate delivery rate check-run shall not exceed 2.0 percent of the mathematical average of 3 runs of at least three tons (3 tonnes) each. The emulsion pump shall deliver MSE to the pugmill with such volumetric consistency that the deviation for any individual delivery rate check-run shall be within 2.0 percent of the mathematical average of 3 runs of at least 300 gallons (1135 L) each. The water pump shall deliver water to the pugmill with such volumetric consistency that the deviation for any individual delivery rate check-run shall be within 2.0 percent of the mathematical average of 3 runs of at least 300 gallons (1135 L) each.

The MSE storage tank shall be located immediately before the emulsion pump and shall be equipped with a device which will automatically shut down the power to the emulsion pump and aggregate belt feeder when the MSE level is lowered to a point where the pump suction line is exposed.

A temperature-indicating device shall be installed in the emulsion storage tank at the pump suction level. The device shall indicate the temperature of the MSE and shall be accurate to within 10°F (5°C).

The belt delivering the aggregate to the pugmill shall be equipped with a device to monitor the depth of aggregate being delivered to the pugmill. The device for monitoring the depth of aggregate shall automatically shut down the power to the aggregate belt feeder whenever the depth of aggregate is less than the target depth of flow. A second device shall be located where the device will monitor the movement of the aggregate belt by detecting revolutions of the belt feeder. The devices for monitoring no flow or belt movement shall automatically shut down the power to the aggregate belt when the aggregate belt movement is interrupted. The device to detect revolutions of the belt feeder will not be required where the aggregate delivery belt is an integral part of the drive chain. To avoid erroneous shutdown by normal fluctuation, a delay of 3 seconds will be permitted between sensing and shutdown of the operation.

SP22-04 MIXING AND SPREADING EQUIPMENT

The micro-surfacing shall be mixed in continuous pugmill mixers of adequate size and power for the type of micro-surfacing to be placed. All indicators shall be in conformance with the provisions of these special provisions and shall be in working order prior to commencing mixing and spreading operations.

Mixer-spreader trucks shall be equipped to proportion the MSE, water, aggregate, mineral filler, and set-control additives by volume. Rotating and reciprocating equipment on mixer-spreader trucks shall be covered with metal guards.

The mixer-spreader truck shall not be operated unless low-flow and no-flow devices and revolution counters are in good working condition and functioning and metal guards are in place. Indicators required by these special provisions shall be visible while walking alongside the mixer-spreader truck.

Aggregate feeders shall be connected directly to the drive on the emulsion pump. The drive shaft of the aggregate feeder shall be equipped with a revolution counter reading to the nearest one-tenth of a revolution.

Each mixing unit to be used in the performance of the work shall be calibrated in the presence of the Engineer prior to the start of the project. Previous calibration documentation covering the exact materials to be used will be acceptable, provided that no more than 60 calendar days have lapsed. The documentation shall include an individual calibration of each material at various settings that can be related to the machine metering devices. Any component replacement affecting material proportioning requires that the machine be recalibrated. No machine will be allowed to work on the project until the calibration has been completed and/or accepted.

Special Provisions

The micro-surfacing mixture shall be spread by means of a spreader box conforming to the following requirements:

Spreader Box

The spreader box shall be capable of placing the micro-surfacing a minimum of 12 feet (3.6 m) wide and shall have strips of flexible rubber belting or similar material on each side of the spreader box and in contact with the pavement to prevent the loss of micro-surfacing from the box. Spreader boxes over eight feet (2.38 m) in application width shall have baffles, reversible motor driven augers or other suitable means to insure uniform application on superelevated sections and shoulder slopes. Spreader box skids shall be maintained in such manner as to prevent chatter (wash boarding) in the finished mat. The spreader box in use shall be clean and free of micro-surfacing and MSE at the start of each work shift.

The spreader box shall have a series of strike-off devices at the rear of the box. The leading strike-off device shall be fabricated of steel, stiff rubber or other suitable material. The number of strike-off devices shall be determined by the Contractor. The first strike-off device shall be designed to maintain close contact with the pavement during the spreading operations, shall obtain the thickness required, and shall be capable of being adjusted to the various pavement cross sections for application of a uniform micro-surfacing finished surface. The final strike-off device shall be fabricated of flexible material suitable for the intended use and shall be designed and operated to ensure a uniform texture is achieved in the finished surface of the micro-surfacing. The final strike-off device shall be cleaned or changed daily if problems with longitudinal scouring occur.

Flexible fabric drags attached to the rear of the spreader box shall not be used.

Micro-surfacing spreader box shall be wrapped in plastic or other suitable material to prevent micro-surfacing materials being dropped on the haul routes while in transit to and from the stockpile area or from one project street to another. Failure to comply with this specification shall be grounds for suspension of work until corrective measures are implemented.

SP22-05 SURFACE PREPARATION

The surface to receive micro-surfacing shall be prepared in accordance with the requirements specified for preparing surfaces to receive asphaltic emulsion as specified in Section 10-1.8, "Surface Preparation", of the Standard Specifications and these Special Provisions.

Pavement must be completely dry prior to the application of micro-surfacing.

Special care shall be taken to clean the pavement before the micro-surfacing application. Immediately prior to the application of the micro-surfacing the surface to receive the micro-surfacing shall be cleaned by vacuum sweeping, flushing or other means necessary to remove all vegetation, loose particles of paving, all dirt, and all other extraneous material. Pavements impregnated with grease, oil, or fuel shall be thoroughly scrubbed with water and an approved detergent and then flushed and swept clean. Wash water shall be vacuumed up and disposed of and shall not be permitted to enter the storm drain system. Contractor shall be responsible for sweeping the streets until sufficiently cleaned to the satisfaction of the Engineer. Streets shall be swept from face of curb to face of curb. Pavement missed by or inaccessible to broom sweepers shall be swept manually or by other methods approved by the Engineer.

Special Provisions

All vegetation and debris removed from the roadway surface shall become the property of the Contractor and shall be disposed of in accordance with Section 6-16 "Disposal Outside Project Limits" of the General Provisions of the Standard Specifications.

All existing temporary and permanent pavement markers and temporary delineation shall be removed in accordance with Section SP17, "Existing Highway Facilities" of these Special Provisions.

All surface metal utility covers (including survey monuments) shall be protected by thoroughly covering the surface with an appropriate adhesive and paper or plastic. No adhesive material shall be permitted to cover, seal or fill the joint between the frame and cover of the structure. Covers are to be uncovered and cleaned of chip seal material by the end of the same work day.

SP22-06 PLACING

Micro-surfacing shall be placed a minimum of seven(7) calendar days after the completion of the chip seal on streets that are designated for cape seal on the project plans or in these special provisions.

The micro-surfacing mixture shall be uniformly spread on the existing surfacing within the rate specified without spotting, rehandling or otherwise shifting of the mixture.

The micro-surfacing mixture shall not be placed when the ambient temperature is below 50 °F (10°C) or during unsuitable weather. Micro-surfacing shall not be placed if rain is imminent or if there is the possibility that there will be freezing temperatures within 24 hours.

Micro-surfacing shall be spread at the rate of 14-18 lbs. of dry aggregate per square yard.

Longitudinal joints shall correspond with the edges of the traffic lanes. The Engineer may permit other patterns of longitudinal joints if the patterns will not adversely affect the quality of the finished product. Through traffic lanes shall be spread in full lane widths only. Longitudinal joints common to 2 traffic lanes shall be butt joints with overlaps not to exceed 3 inches (76 mm). Building paper shall be placed at the transverse joints to avoid double placement of the micro-surfacing. Other suitable methods to avoid double placement of the micro-surfacing will be allowed. Hand tools shall be available to remove spillage. The mixture shall be uniform and homogeneous after placing on the surfacing and shall not show separation of the MSE and aggregate after setting. The completed surface shall be of uniform texture and free from ruts, humps, depressions, or irregularities.

Adequate means shall be provided to protect the micro-surfacing from damage by traffic until such time that the mixture has cured sufficiently so that the micro-surfacing will not adhere to or be picked up by the tires of vehicles.

Any micro-surfacing material that is spilled onto concrete gutter surfaces shall be removed on the same day the material was placed. Concrete surfaces that are stained due to spilled slurry materials shall be cleaned to the satisfaction of the Engineer.

SP22-07 ROLLING

The surface of the street or parking lot shall be rolled by a self-propelled, 10-ton (maximum) pneumatic tire roller equipped with a water spray system. All tires shall be inflated per manufacturer's specifications. Rolling shall not start until the micro surfacing has cured sufficiently to avoid damage by the roller. Areas which require rolling shall receive a minimum of two (2) full coverage passes.

Special Provisions

SP22-08 STREET SWEEPING

Once the micro-surfacing has cured and is open to traffic, any excessive raveling of the aggregate from the micro-surfacing shall be swept up by the Contractor. Sweeping shall continue until such time when the raveling ceases. Failure to provide adequate sweeping shall result in the City performing said work at the Contractor's sole expense, which shall be deducted from any monies due to the Contractor. Sweeping by City forces shall not relieve the Contractor of any liability arising from his failure to comply with these Special Provisions.

SP22-09 REPAIR OF EARLY DISTRESS

If bleeding, raveling, delamination, rutting, or washboarding occurs within 60 days after placing the micro-surfacing, the Contractor shall diligently pursue repairs by any method approved by the Engineer. The Contractor shall not be relieved from maintenance until repairs have been completed. Inability to provide a satisfactory repair shall be ground for the Engineer rejecting the micro-surfacing as defective. The Engineer's decision is final regarding whether a repair is considered satisfactory.

SP22-10 MEASUREMENT AND PAYMENT

The contract unit price paid per square yard "**Micro-Surfacing, Type II,**" shall be considered as full compensation for furnishing all labor, materials, tools, equipment and incidentals and for doing all the work involved in micro-surfacing, including but not limited to; site preparation, cleanup, protecting utility and manhole covers, applying micro-surfacing, rolling, protection during curing, street sweeping and all other incidental work required to complete the work as shown and specified.

SPECIAL PROVISIONS SECTION SP-23

NOT USED

SPECIAL PROVISIONS SECTION SP-24

RUBBERIZED CHIP SEAL
(BID ITEM NO. 13)

SP24-01 GENERAL

The provisions of Section 10, "Bituminous Seal Coats," of the Technical Provisions of the Standard Specifications shall apply in their entirety except as modified or supplemented herein.

Rubberized chip seal shall consist of an application of rubberized asphalt binder and hot screenings precoated with paving asphalt. Rubberized chip seal shall conform to the provisions specified for seal coat in Section 37-1, "Seal Coats," of the State Standard Specifications and these special provisions.

SP24-02 MATERIALS

SP24-02.1 PAVING ASPHALT

Paving asphalt shall conform to Section 92, "Asphalts," of the State Standard Specifications and shall be steam refined paving asphalt, viscosity grade PG64-16.

The temperature of the paving asphalt and extender oil shall be between 350°F and 425°F at the time the rubber is added and reacted for a minimum of 45 minutes at this temperature to produce a product with the following properties:

Viscosity at 400°F	ASTM E-102	1,500 min
Softening Point	R&B	120°F min
Flex Temperature	90 Bend Test	20°F max

The asphalt-rubber binder shall consist of between 78 and 82 percent paving asphalt, (including extender oil) and between 18 and 22 percent rubber (by weight to the total asphalt-rubber mixture).

The asphalt rubber mixture shall be spread as soon as possible after reaching the desired consistency. In the event a delay occurs when the product is ready to be applied, the heat will be turned off until the job resumes. The material shall not be held at temperatures over 400°F for more than 4 hours.

SP24-02.2 ASPHALT MODIFIER

The asphalt modifier shall be a resinous, high flash point aromatic hydrocarbon meeting the following test requirements:

Viscosity, SSU @ 100°F	ASTM D-88	1,500 min
Flash Point, COC, 0 °F	ASTM D-92	390 min
Molecular Analysis:		
Asphaltenes-, % by weight	ASTM D-2007	0.1 max
Aromatics, % by weight	ASTM D-2007	55.0 min

Special Provisions

The asphalt modifier shall be proportionately added to the paving asphalt at the production site where the asphalt-rubber binder is blended and reacted. Asphalt modifier shall be added at an amount of 2.5 percent to 6.0 percent by weight of the paving asphalt based on the recommendation of the asphalt-rubber binder supplier. The paving asphalt shall be at a temperature of not less than 375°F nor more than 440°F when the asphalt modifier is added. If the asphalt modifier is combined with the paving asphalt, before being blended with the CRM, the combined paving asphalt and asphalt modifier shall be mixed by circulation for a period of not less than 20 minutes. This premixing of asphalt modifier and paving asphalt will not be required when all ingredients of the asphalt-rubber binder are proportioned and mixed simultaneously.

SP24-02.3 CRUMB RUBBER MODIFIER (CRM)

Crumb rubber modifier (CRM) shall consist of a combination of scrap tier CRM and high natural CRM. The scrap tire CRM shall consist of ground or granulated rubber derived from any combination of automobile tires, truck tires or tire buffings. The high natural CRM shall consist of ground or granulated rubber derived from materials that utilize high natural rubber sources.

The Contractor shall provide a certificate of compliance stating that the rubberized asphalt binder contains a minimum of 15% by weight of 100% California waste tire-derived crumb rubber per ton of rubberized binder.

Steel and fiber separation shall be accomplished by any method. Cryogenic separation, if utilized, shall be performed separately from and prior to grinding or granulating.

CRM shall be ground or granulated at ambient temperature. Cryogenically produced CRM particles that pass through the grinder or granulator without being ground or granulated, respectively, shall not be used.

CRM shall not contain more than 0.01 percent wire (by weight of CRM) and shall be free of other contaminants, except fabric. Fabric shall not exceed 0.05 percent by weight of CRM. A certificate of compliance certifying these percentages shall be furnished to the Engineer.

The length of an individual CRM particle shall not exceed 3/16 inch.

The CRM shall be sufficiently dry so that the CRM will be free flowing and will not produce foaming when combined with the blended paving asphalt and asphalt modifier mixture. Calcium carbonate or talc may be added at a maximum amount of 3 percent by weight of CRM to prevent CRM particles from sticking together. The CRM shall have a specific gravity between 1.1 and 1.2 as determined by California Test 208. Scrap tire CRM and high natural CRM shall be delivered to the production site in separate bags and shall be sampled and tested separately. CRM material shall conform to the following requirements as determined by ASTM Designation D297:

<u>Test Parameter</u>	<u>Scrap Tire CRM Percent</u>		<u>High Natural CRM Percent</u>	
	<u>Min</u>	<u>Max</u>	<u>Min</u>	<u>Max</u>
Acetone Extract	6.0	16.0	4.0	16.0
Rubber Hydrocarbon	42.0	65.0	50.0	0.0
Natural Rubber Content	22.0	39.0	40.0	48.0
Carbon Black Content	28.0	38.0	0.0	0.0
Ash Content	0.0	8.0	0.0	0.0

Special Provisions

The rubber shall conform to the following gradation requirements when tested in accordance with ASTM Designation C136.

<u>High Natural CRM Gradation</u>		<u>Scrap Tire CRM Gradation</u>	
<u>Sieve Size</u>	<u>Percent Passing</u>	<u>Sieve Size</u>	<u>Percent Passing</u>
No. 8	100	No. 8	100
No. 10	100	No. 10	90-100
No. 16	85-100	No. 16	32-88
No. 30	20-98	No. 30	1-30
No. 50	2-40	No. 50	0-15
No. 100	0-10	No. 100	0-10
No. 200	0-5	No. 200	0-5

SP24-02.4 ASPHALT RUBBER BINDER

Asphalt-rubber binder shall consist of a mixture of paving asphalt, asphalt modifier, and crumb rubber modifier. At least 15 days before its intended use the Contractor shall supply the Engineer, for approval, a binder formulation. The binder formulations shall consist of the following information:

- A. Paving Asphalt and Modifiers:
 - 1. Source and grade of paving asphalt
 - 2. Source and identification (or type) of modifiers used
 - 3. Percentage of asphalt modifier by weight of paving asphalt
 - 4. Percentage of the combined blend of paving asphalt and asphalt modifier by total weight of asphalt-rubber binder to be used
 - 5. Laboratory test results for test parameters shown in these special provisions

- B. Crumb Rubber Modifier (CRM):
 - 1. Source and identification (or type) of scrap tire and high natural CRM
 - 2. Percentage of scrap tire and high natural CRM by total weight of the asphalt-rubber blend
 - 3. If CRM from more than one source is used, the above information will be required for each CRM source used
 - 4. Laboratory test results for test parameters shown in these special provisions

- C. Asphalt-Rubber Binder:
 - 1. Laboratory test results for test parameters shown in these special provisions
 - 2. The minimum reaction time and temperature

The method and equipment for combining the paving asphalt, asphalt modifier, and CRM shall be so designed and accessible that the Engineer can readily determine the percentages by weight for each material being incorporated into the mixture.

Special Provisions

The proportions of the materials, by total weight of asphalt-rubber binder, shall be 79 percent \pm 1 percent combined paving asphalt and asphalt modifier and 21 percent \pm 1 percent CRM. However, the minimum amount of CRM shall not be less than 20.0 percent. Lower values shall not be rounded up. The CRM shall be combined at the production site and shall contain 76 percent \pm 2 percent scrap tire CRM and 24 percent \pm 2 percent high natural CRM, by weight.

The paving asphalt and asphalt modifier shall be combined into a blended mixture that is chemically compatible with the crumb rubber modifier to be used. The blended mixture shall be considered to be chemically compatible when the mixture meets the requirements for asphalt-rubber binder (after reacting) found in these special provisions.

The blended paving asphalt and asphalt modifier mixture and the CRM shall be combined and mixed together at the production site in a blender unit to produce a homogeneous mixture.

The temperature of the blended paving asphalt and asphalt modifier mixture shall not be less than 375°F nor more than 440°F when the CRM is added. The combined materials shall be reacted for a minimum of 45 minutes after incorporation of the CRM at a temperature of not less than 375°F nor more than 425°F. The temperatures shall not be higher than 10°F below the actual flash point of the asphalt-rubber binder.

After reacting, the blended asphalt-rubber binder shall conform to the following requirements:

Blended Asphalt-Rubber Binder

<u>Test Parameter</u>	<u>ASTM Test Method</u>	<u>Requirement</u>	
		<u>Min</u>	<u>Max</u>
Cone Penetration at 25°C, 1/10 mm	D217	25	60
Resilience at 25°C, Percent rebound	D5329	18	40
Field Softening Point, °C	D36	55	88
Viscosity @ 190°C, Pa*s(x10 ⁻³)	See Note	1500	2500

Note:

The viscosity test shall be conducted using a hand held Haake Viscometer Model VT-02 with rotor 1, 24 mm depth x 53mm height, or equivalent. The reacted Asphalt-Rubber binder shall be maintained at a temperature of not less than 190°C nor more than 219°C.

If a material in a batch of Asphalt-Rubber binder is not used with-in six hours after the reaction period is complete, heating of the material shall be discontinued. When the Asphalt-Rubber binder temperature cools below 375°F and is then reheated, it shall be considered a reheat cycle. The total number of reheat cycles shall not exceed two (2). The binder material shall be uniformly reheated to a temperature of not less than 375°F. Additional scrap tire CRM may be added to the reheated Asphalt-Rubber binder and reacted for a minimum of 30 minutes and shall not exceed 10 percent of the total binder weight. Reheated Asphalt-Rubber binder shall conform to the requirements for blended Asphalt-Rubber binder.

SP24-02.5 SCREENINGS

The screenings shall consist of washed aggregate that is hard, tough and sound. At least 90% by weight of the screenings shall consist of crushed particles as determined by California test method No. 205.

Special Provisions

GRADATION

<u>Sieve Sizes</u>	<u>Percent Passing</u>
1/2"	100
3/8"	70-85
#4	0-15
#16	0-5
#200	0-1

Note: This gradation is not a Caltrans standard specification for a 9.5 mm X 3.35 mm (3/8" x #6) chip.

TESTING REQUIREMENTS

<u>Test</u>	<u>CA Test Method</u>	<u>Requirements</u>
Loss in Los Angeles Rattler (after 100 revolutions)	211	10% max
Loss in Los Angeles Rattler (after 500 revolutions)	211	40% max
Film Stripping	302	25% max
Cleanness Value	227	80 min
Durability	229	52 min

All screenings shall be preheated to a temperature between 260°F and 325°F and then pre-coated with hot mixed, paving-grade asphalt applied at a rate of 0.5 to 1.0 percent of paving asphalt by weight of dry aggregate and the amount shall be determined by the Contractor. The pre-coating of aggregate shall be performed in an asphalt concrete plant. Stockpiling of Aggregate after preheating and pre-coating with asphalt will not be permitted.

Dusty screenings will be rejected. Stockpiling of screening after preheating and pre-coating will not be permitted.

Canvas or similar covers that completely cover each load of pre-coated aggregate shall be used during hauling to minimize temperature drop of the pre-coated aggregate. Aggregate shall be spread when the temperature of the pre-coated aggregate is not less than 225°F.

Contractor shall arrange with the batch plant to coordinate the pre-coating application such that only coated chips are produced. Experience has shown that if a load of asphalt is produced in the same drum, the next load of chips will contain excessive dust and fine material, and may be cause for rejection of the load. The drum shall also be cleaned of all fine material prior to commencing the pre-coating operations.

No single aggregate grading of Cleanness Value test shall represent more than 300 tons or one day's production, whichever is smaller. Representative samples for grading requirements will be taken prior to pre-coating with paving asphalt. Representative samples for Cleanness Value test will be taken immediately prior to preheating the material.

SP24-03 STREET SURFACE PREPARATION

The surface to receive chip seal shall be prepared in accordance with the requirements specified for preparing surfaces to receive asphaltic emulsion as specified in Section 10-1.8, "Surface Preparation", of the Standard Specifications and these Special Provisions.

Special Provisions

Pavement must be completely dry prior to the application of asphalt rubber.

Special care shall be taken to clean the pavement before the chip seal application. Immediately prior to the application of the chip seal the surface to receive the chip seal shall be cleaned by vacuum sweeping, flushing or other means necessary to remove all vegetation, loose particles of paving, all dirt, and all other extraneous material. Vegetation shall be removed from cracks in pavement and at the interface of pavement and gutter prior to sweeping. The Contractor may blow the cracks clean of loose materials with a high pressure air nozzle (90 psi or greater and free of oil). Pavements impregnated with grease, oil, or fuel shall be thoroughly scrubbed with water and an approved detergent and then flushed and swept clean. Wash water shall be vacuumed up and disposed of and shall not be permitted to enter the storm drain system. Contractor shall be responsible for sweeping the streets until sufficiently cleaned to the satisfaction of the Engineer. Streets shall be swept from face of curb to face of curb. Pavement missed by or inaccessible to broom sweepers shall be swept manually or by other methods approved by the Engineer.

All vegetation and debris removed from the roadway surface shall become the property of the Contractor and shall be disposed of in accordance with Section 6-16 "Disposal Outside Project Limits" of the General Provisions of the Standard Specifications.

All existing temporary and permanent pavement markers and temporary delineation shall be removed in accordance with Section SP17, "Existing Highway Facilities" of these Special Provisions.

All surface metal utility covers (including survey monuments) shall be protected by thoroughly covering the surface with an appropriate adhesive and paper or plastic. No adhesive material shall be permitted to cover, seal or fill the joint between the frame and cover of the structure. Covers are to be uncovered and cleaned of chip seal material by the end of the same work day.

SP24-04 APPLICATION OF RUBBERIZED ASPHALT BINDER

Rubberized asphalt binder shall be applied in conformance with the provisions specified for applying asphaltic emulsion in Section 37-1.05, "Applying Asphaltic Emulsion," of the Standard Specifications, except the second, third, fourth, and fifth paragraphs shall not apply.

The application rate of the rubberized asphalt material shall be within the range of 0.55 to 0.65 gallons per square yard. The exact rate of application will be determined by the Engineer. The distribution shall not vary more than 15 percent transversely from the average as determined by tests, not more than 10 percent longitudinally from the specified rate of application as determined by California Test 399. The binder shall be applied at a minimum temperature of 360°F.

Rubberized asphalt binder shall not be applied when weather conditions are unsuitable or when the pavement is damp or wet. Excessive wind is considered an unsuitable weather condition. Asphalt binder shall be applied only when the atmospheric temperature is 65°F or above and the pavement surface temperature is 55°F or above.

Distributor bar height, distribution speed, and shielding materials shall be utilized to reduce the effects of wind upon spray distribution as directed by the Engineer.

A minimum of two (2) truck mounted, self-powered distributor units shall be used. Tractor-trailer spreader units will be allowed. Each unit is to be equipped with a hot oil heating unit to heat the asphalt to the required

Special Provisions

temperature for blending with the rubber, a mixing unit capable of producing a homogeneous mixture of asphalt and rubber, pumps capable of spraying asphalt rubber within a tolerance ± 0.03 gallons per square yard of the specified rate, and a fully circulating spray bar capable of applying asphalt rubber without a streaked or otherwise irregular pattern. The spray bar shall be equipped with a set of controls so that the asphalt rubber application may be controlled by a “bootman”. The “bootman” shall accompany the distributor and ride in a position so that all spray bar nozzles are in his full view and readily accessible for unplugging. The distributor units shall also be equipped with a tachometer, pressure gauges, volume measuring devices, computerized rate control, and a temperature gauge.

SP24-05 SPREADING SCREENINGS

Screenings for chip seal shall be spread in accordance with the requirements specified for spreading screenings on asphaltic emulsion in Section 37-1.06, “Spreading Screenings”, of the State Standard Specifications, except for the second, sixth, seventh and eighth paragraphs shall not apply. In addition the following shall apply:

- a. A self-propelled screenings spreader shall be used and be equipped with a screenings hopper in the rear, belt conveyors to carry the screenings to the front and a spreading hopper equipped with a full-width distribution auger and spread roll.
- b. **Screenings shall be applied at a rate of 26 to 30 pounds per square yard.** The exact rate of application will be determined by the Engineer.

Screenings shall be spread when the temperature of the pre-coated screenings is not less than 225°F.

The screenings spreader shall not be more than 50 feet behind the asphalt rubber binder distribution truck unless otherwise ordered by the Engineer. Trucks hauling screenings shall be kept clear of the freshly placed screenings until ready to dump screenings in the spreader equipment.

- c. Trucks for hauling screenings shall be tailgate discharge and shall be equipped with a device to lock onto the hitch at the rear of the screenings spreader. Haul trucks shall be compatible with the screenings spreader so that the dump bed will not push down on the spreader when fully raised or have too short of a bed which results in screenings spilling while dumping into the receiving hopper.

SP24-06 FINISHING AND ROLLING OPERATIONS

Chip seal shall be finished and screenings compacted in accordance with Section 37-1.07, “Finishing” of the State Standard Specifications, except that the second, third, fourth, and fifth paragraph shall not apply. In addition the following shall apply:

- a. A minimum of three (3) pneumatic tired rollers conforming to the requirements specified in Section 39-5.02, “Compacting Equipment”, of the State Standard Specifications shall be used, except that the rollers shall carry a minimum loading of 3,000 pounds on each wheel and air pressure of between 95 and 105 pounds per square inch in each tire.
- b. A minimum of one-foot strip shall be swept with a self-propelled kick broom along the edge of the roadway prior to chip sealing the next lane. All loose aggregate shall be pushed back onto the lane just chip sealed.
- c. In the course of construction where the asphalt-rubber distributor truck creates a joint by stopping at some point along the length of the roadway, the screenings spreader shall stop short of this joint,

Special Provisions

leaving a small strip of uncovered asphalt rubber. This is to prevent an overlapping double thickness joint from being created once work resumes. All reasonable precautions shall be taken to avoid skips and overlaps at joints. Any defect shall be corrected at the Contractor's expense by use of a shovel and/ or broom prior to continuing operations.

- d. The seal coat shall be applied in such a manner that the joint between the new and existing surface is neat and uniform in appearance true to the line show on the plans and as established by the Engineer. The cut-off of asphaltic binder shall be made on building paper or similar material spread over the surface.
- e. Initial rolling of the asphalt-rubber chip seal shall consist of a minimum of one complete coverage with three pneumatic-tired rollers working in tandem and shall begin immediately behind the screenings spreader. The distance between the rollers and the screenings spreader shall not exceed 200 feet at any time during the spreading of screenings operations.
- f. A minimum of three additional complete coverages with the three pneumatic-tire rollers shall be made after the initial coverage on the asphalt-rubber chip seal.
- g. In addition to the three pneumatic-tired rollers one 12-14 ton steel wheel roller shall be used on the final pass as the finish roller.

SP24-07 FINAL SWEEPING

A minimum of three (3) self propelled power brooms shall be used that are capable of cleaning the existing pavement and removing loose screenings without dislodging screenings set in the asphalt-rubber mixture. Gutter brooms or steel-tined brooms shall not be used.

Sweeping of the chip seal shall commence one hour after completion of the rolling operation or as directed by the Engineer. Sweeping shall be completed prior to allowing uncontrolled traffic on the road surface. On the day of the actual chip seal operations, three power sweepers shall be used on those streets being chip sealed that day. Two sweepers shall be used to remove excess screenings from the road surface, and one sweeper shall directly follow the chip seal operations and be used to clean the surrounding streets and road surfaces outside of the project area to avoid tracking loose material. During sweeping the day of the chip seal, water shall not be used in the removal of loose material.

The Contractor must remove all loose chips from the street surface per the Engineer's specifications. A broom sweeper may not be able to pick up excess chips on cul-de-sacs. The Contractor is responsible for removing these chips through the use of a vacuum sweeper or other acceptable means as approved by the Engineer.

Three (3) additional sweepings shall be performed. The first sweeping shall be done one day after placement of the chip seal, the second 2 days after placement of the chip seal and the final sweeping shall occur 7 days after placement of the chip seal and prior to placing the slurry seal or micro-surfacing, if any. The Contractor shall spray water on these subsequent sweepings for dust removal. Excess screenings shall be removed from the job site by the Contractor. At the end of each day's sweeping operations the Contractor shall remove any and all loose materials from sidewalks, landscaped areas and adjacent properties manually or by any other means acceptable to the Engineer.

SP24-08 MEASUREMENT AND PAYMENT

The contract unit price paid per square yard "Rubberized Chip Seal," shall be considered as full compensation for furnishing all labor, materials, tools, equipment and incidentals and for doing all the work involved in installing rubberized chip seal, including but not limited to; site preparation, crack cleaning, cleanup,

Special Provisions

protecting utility and manhole covers, applying chip seal, street sweeping and all other incidental work required to complete the work as shown and specified.

SPECIAL PROVISIONS SECTION SP-25

CONCRETE CONSTRUCTION

(BID ITEM NO. 6 AND 7)

SP25-01 GENERAL

The provisions of Section 17, "Concrete Construction", of the Technical Provisions of the Standard Specifications shall apply in their entirety except as modified or supplemented herein.

Attention is directed to Section SP17-02, "Removals" of concrete facilities.

All new curb, gutter, sidewalk, and driveways shown on the contract Plans or described in these Special Provisions shall conform to the latest applicable Contra Costa County Public Works Department "Standard Plans" unless otherwise shown or specified on the plans and these Special Provisions. This work shall include placing new aggregate base under new concrete improvements. The County specified portland cement concrete (PCC) and aggregate base thickness requirements for driveways, valley gutters and curb and gutter are amended as follows:

All new concrete work to be placed on aggregate base shall be founded on a minimum six (6)-inch thick layer of Class 2 aggregate base, compacted to 95% relative compaction.

Aggregate base shall be Class 2 aggregate base conforming to Section SP-18, "Aggregate Base", of these Special Provisions.

SP25-02 CONCRETE REQUIREMENTS

All concrete shall receive a light broom finish.

Backfill any void or space between new concrete facilities and adjacent surrounding ground with like materials. This material is typically topsoil, gravel or base rock. Fill material shall be placed and compacted to the top of the new concrete improvements and sloped at a maximum of 3:1 to conform with the existing terrain. The fill material shall be compacted to 90% relative compaction. In areas where topsoil is placed a 2 inch layer of mulch shall be placed over the topsoil.

Concrete used for minor concrete structures shall be Class 520-C-2500. The maximum slump shall be four (4) inches.

Concrete work shall not be backfilled within seventy-two (72) hours of pouring.

SP25-03 MINOR CONCRETE STRUCTURES

The work herein shall consist of, but not be limited to, constructing new curb, gutter, sidewalk and driveway improvements. The work shall include grading and preparations of the subgrade, doweling to existing improvements, and placement and compaction of aggregate base.

Special Provisions

Curb and Gutter Removal and Replacement Locations:

El Nido Ranch Road	(Across from Oak Knowl)	--	16	LF
El Nido Ranch Road	(West of HWY 24 on Ramps)	--	10	LF
School Street	(Driveway to School Playground)	--	40	LF

Sidewalk/Driveway Removal and Replacement Locations:

School Street	(Driveway to School Playground)	--	150	SF
School Street	(East of Intersection with First Street)	--	85	SF

Curb and gutter shall match the shape of the adjacent rolled curb and gutter.

Dowels, #4x12" long shall be installed at the junction between new and existing facilities. The dowels shall be in drilled holes, grouted and spaced in conformance with the details shown on CCC Standard Plan CA74i. All dowels shall have a minimum 1 1/2" concrete cover. Full compensation for "Doweling" shall be considered as included in the various concrete items of work and no additional compensation will be allowed therefor.

The Contractors attention is directed to the existence of private irrigation facilities located behind the existing curb and gutter. In some cases the irrigation systems may run directly behind the existing curb and gutter and may become damaged during the removal and or installation of new concrete improvements. When irrigation systems are damaged the Contractor shall repair these systems the same day they are damaged. The Contractor shall test the system after the repair is completed to ensure the system is fully functional. This work shall be considered as included in the bid item price for the various concrete items.

SP25-04 MEASUREMENT AND PAYMENT

The contract price paid per linear foot for "**Remove and Replace Concrete Curb and Gutter**" and the contract price paid per square foot for "**Remove and Replace Concrete Sidewalk/Driveway**" shall include full compensation for furnishing all labor, supervision, materials, tools, equipment and incidentals necessary to complete the work including, but not limited to, sawcutting, removing existing curb, gutter, sidewalk and driveway, removing asphalt paving, furnishing new concrete, furnishing new asphalt pavement; excavation; loading; hauling; disposal; forming; backfill; reinforcement; doweling; aggregate base; asphalt; compaction; placing select fill material behind new concrete improvements; and all other work necessary to construct the facility complete, in place as shown on the plans as specified in the Standard Specifications and these Special Provisions, and as directed by the Engineer and no additional compensation shall be allowed therefor.

SPECIAL PROVISIONS SECTION SP-26

TEMPORARY PAVEMENT DELINEATION

(BID ITEM NO. 15)

SP26-01 GENERAL

Temporary pavement delineation shall be furnished, placed, maintained and removed in accordance with the provisions in Section 12-3.01, "General", of the State Specifications and these Special Provisions. Nothing in these Special Provisions shall be construed as to reduce the minimum standards specified in the "Manual of Uniform Traffic Control Devices" and the California Supplement or as relieving the Contractor from his/her responsibility as provided in Section 7-1.09, "Public Safety", of the State Specifications.

Whenever the work causes obliteration of pavement delineation, temporary or permanent pavement delineation shall be in place prior to opening the traveled way to public traffic.

Temporary pavement delineation placed on the asphalt concrete base course shall be temporary raised markers for lane lines and paint with reflective glass beads for legends. Temporary permanent delineation placed on the final pavement surface shall be temporary tape and temporary raised markers. The Contractor shall install all temporary pavement delineation including lane lines, shoulder lines, and all other delineation at the same layout, size and width and following the same or equivalent striping patterns or details as the obliterated pavement delineation it is replacing or as the planned permanent striping shown on the Plans. Failure by the Contractor to satisfy this requirement shall be sufficient cause for the City to have the required temporary delineation installed and all costs for this work, including a 50% administrative markup, will be deducted from any progress payments due to the Contractor. The intent of this requirement is to have a complete temporary pavement delineation installation in place on any traveled way open to public traffic.

All work necessary, including any required lines or marks, to establish the alignment of temporary pavement delineation shall be performed by the Contractor. Surfaces to receive temporary pavement delineation shall be dry and free of dirt and loose material. Temporary pavement delineation shall not be applied over existing pavement delineation or other temporary pavement delineation. Temporary pavement delineation shall be maintained until superseded or replaced with a new pattern of temporary pavement delineation or permanent pavement delineation.

Temporary pavement delineation that is damaged from any cause during the progress of work shall be immediately repaired or replaced by the Contractor at his/her own expense.

SP26-02 TEMPORARY PAVEMENT DELINEATION - TAPE AND MARKERS

All temporary pavement delineation to be placed on the top layer of new asphalt pavement or on existing pavements to remain, shall be temporary raised reflective pavement markers and temporary removable traffic tape. Painted striping or markings in place of temporary markers and tape is not allowed. The temporary markers and tape shall be in place prior to opening the traveled way to the public.

The minimum lane line and centerline delineation to be provided shall be temporary reflective raised pavement markers placed at longitudinal intervals of not more than twenty (20) feet. Existing double yellow stripes shall be delineated with two (2) reflective raised pavement markers placed side-by-side at not more than twenty (20) foot intervals. The temporary reflective raised pavement markers shall be the same color as the lane line or

Special Provisions

centerline the markers replace. Temporary reflective raised pavement markers shall be, at the option of the Contractor, one of the temporary pavement markers listed for short term day/night use (14 days or less) or long term day/night use (6 months or less) in the latest listing of “*Prequalified and Tested Signing and Delineation Materials*” maintained by Caltrans.

Temporary pavement markers for long term day/night use (6 months or less)

- Vega Molded Products “Temporary Road Marker” (3” x 4”)

Temporary pavement markers for short term day/night use (14 days or less)

- Apex Universal, Model 932
- Bunzl Extrusion, Model T.O.M., T.R.P.M. and “HH” (High Heat)
- Hi-Way Safety, Inc., Model 1280/1281
- Glowlite, Inc., Model 932

Removable type traffic tape and pavement marking tape shall be one of the temporary removable construction grade types listed in the latest listing of “*Prequalified and Tested Signing and Delineation Materials*” maintained by Caltrans.

Temporary removable striping and pavement marking tape

- Advanced Traffic Marking, ATM Series 200
- Brite-Line, Series 100
- Garlock Rubber Technologies, Series 2000
- P.B. Laminations, Aztec, Grade 102
- Swarco Industries, “Director-2”
- Trelleborg Industries, R140 Series
- 3M, Series 620 “CR”, and Series A750
- 3M, Series A145, Removable Black Line Mask
(Black Tape: for use only on Asphalt Concrete Surfaces)
- Advanced Traffic Marking Black “Hide-A-Line”
(Black Tape: for use only on Asphalt Concrete Surfaces)
- Brite-Line “BTR” Black Removable Tape
(Black Tape: for use only on Asphalt Concrete Surfaces)
- Trelleborg Industries, RB-140
(Black Tape: for use only on Asphalt Concrete Surfaces)

Removable type traffic tape shall be applied in accordance with the manufacturer’s installation instructions and shall be rolled slowly with a rubber tired vehicle or roller to ensure complete contact with the pavement surface. Traffic stripe tape shall be applied straight on tangent alignments and on a true arc on curved alignments. Traffic stripe tape shall not be applied, when the air or pavement temperature is less than 50°F, unless the installation procedures to be used are approved by the Engineer, prior to beginning installation of the tape.

Removable type traffic tape and temporary raised pavement markers shall be removed and disposed of by the Contractor when, as determined by the Engineer, they are no longer required for the direction of public traffic, or the permanent pavement markers and striping have been installed.

Special Provisions

SP26-03 MEASUREMENT AND PAYMENT

The contract lump sum price paid for “**Temporary Pavement Delineation**” shall include full compensation for furnishing all labor, supervision, materials, tools, equipment and incidentals and for doing all the work necessary to lay out, place, maintain, and remove temporary pavement striping, legends, arrows, glue down delineators, markers and markings and all other work as shown on the Plans, as specified in the State Specifications and these Special Provisions, and as directed by the Engineer and no additional compensation shall be allowed therefor.

SPECIAL PROVISIONS SECTION SP-27
PAVEMENT STRIPING, MARKERS AND DELINEATION
(BID ITEM NO. 16-24)

SP27-01 GENERAL

The provisions of Section 15, "Pavement Striping, Markers, and Delineation", of the Technical Specifications of the Standard Specifications shall apply in their entirety except as modified or supplemented herein.

Traffic striping shall be placed in accordance with the applicable details as shown on State Standard Plan A20A through A20D. Pavement markings shall be placed in accordance with the applicable details of State Standard Plans A24A through A24E. Detail numbers shown on the Plans and the contract bid proposal refer to details shown in the State Standard Plans.

Pavement striping and markings shall be placed at the locations shown on the Plans. Contractor shall notify the Engineer a minimum of twenty-four (24) hours in advance of all striping phases. A striping phase shall be any separate day of work and any separate crew including: layout, paint, thermoplastic, buttons or any other crew required to complete work. The Contractor shall provide the name and cell phone number for the striping foreman and the foreman's planned starting time and location. All striping crews must meet on-site each day with the Engineer or the Engineer's representative prior to starting any work.

No payment will be made for any striping performed without notification to the City as stated above.

Temporary "cat tracking" and layout marks shall be placed by the Contractor for all striping (including limit lines and crosswalks). Temporary "cat tracks" shall be approved by the Engineer prior to final striping.

Permanent traffic stripes, pavement markers and pavement markings shall be placed on new asphalt concrete surfacing not less than seven (7) days and not more than fourteen (14) days after the asphalt concrete overlay or final lift has been placed.

During pavement striping and marking operations, the Contractor shall use traffic control as specified in Section SP14, "Traffic Control", of these Special Provisions.

SP27-02 THERMOPLASTIC TRAFFIC STRIPES AND PAVEMENT LEGENDS AND MARKINGS

All limit lines, centerline stripes, shoulder stripes, and legends shall be thermoplastic unless otherwise indicated on the Plans or directed by the Engineer.

Thermoplastic traffic stripes and pavement marking shall conform to the provisions of Section 84-2, "Thermoplastic Traffic Striping and Pavement Markings", of the State Specifications, and these Special Provisions.

During thermoplastic placement, the Contractor shall use traffic control as specified in Section SP14, "Traffic Control", of these Special Provisions.

Special Provisions

SP27-03 PAINTED TRAFFIC STRIPES AND PAVEMENT LEGENDS AND MARKINGS

All limit lines, centerline stripes, shoulder stripes, and legends shall be thermoplastic unless otherwise indicated on the Plans or directed by the Engineer.

Painted traffic stripes and pavement marking shall conform to the provisions of Section 84-3, "Painted Striping and Pavement Markings", of the State Specifications, and these Special Provisions.

During paint placement, the Contractor shall use traffic control as specified in Section SP14, "Traffic Control", of these Special Provisions.

SP27-04 PAVEMENT MARKERS

Pavement markers shall conform to the provisions in Section 85, "Pavement Markers", of the State Specifications, the State Standard Plans, the Standard Specifications, and these Special Provisions.

Non-reflective pavement markers shall be ceramic.

Adhesive shall be hot melt bituminous adhesive conforming to Section 85, "Pavement Markers", of the State Standard Specifications.

Any damage to the newly placed markers due to the failure of the Contractor to protect his/her work and correction of errors shall be repaired by the Contractor at no additional cost.

A blue reflector shall be installed in the center of the traffic lane adjacent to each fire hydrant on all streets within the limits of work. It is the Contractor's responsibility to locate each fire hydrant.

During the pavement marker placement operations, the Contractor shall use traffic control as specified in Section SP14, "Traffic Control", of these Special Provisions.

SP27-05 MEASUREMENT AND PAYMENT

Traffic stripes will be measured by the linear foot along the line of the traffic stripe without deductions for the gaps, shown on the standard details. Deductions shall be made for gaps in the striping at cross streets and driveways.

Measurement for legends and markings shall be per the areas shown on Caltrans Standard Plans.

The contract prices paid per linear foot for various thermoplastic stripes, painted striping, painted curbing and striping details shall include full compensation for furnishing all labor, materials, tools, equipment and incidentals and for doing all the work involved in placing thermoplastic traffic stripes and pavement markers including any necessary cat tracks, dribble lines and layout work, cleaning and preparing surfaces to receive striping thermoplastic stripes, striping painted stripes, pavement markers, adhesive, and all other work as shown on the Plans, the State Standard Plans, and as specified in the Standard Specifications, the State Specifications, and these Special Provisions, and as directed by the Engineer and no additional compensation shall be allowed therefor.

Special Provisions

The contract price paid per square foot for “**Thermoplastic Pavement Legends & Markings**” shall include full compensation for doing all work involved in placing thermoplastic pavement markings and legends, including any necessary layout work and marks and all other work as shown on the Plans, as specified in the Standard Specifications, the State Specifications, and these Special Provisions, and as directed by the Engineer and no additional compensation shall be allowed therefor.

The contract price paid per each for “**Two-Way Reflective Pavement Markers (Blue)**” shall include full compensation for furnishing all labor, materials, tools, equipment and incidentals and for doing all the work involved in placing the markers, as shown on the Plans, the State Standard Plans as specified in the Standard Specifications, the State Specifications and these Special Provisions, and as directed by the Engineer and no additional compensation shall be allowed therefor.

SPECIAL PROVISIONS SECTION SP-28
VEHICLE DETECTION LOOPS
(BID ITEM NO. 8)

SP28-01 GENERAL

Loop wire shall be Type 1. The loop lead-in cable shall be Type B. The “drain” wire from the cable shall be run to the chassis ground in the cabinet. Stop bar loops shall be “Type D”, and all other loops shall be “Type E Loop Detector Configuration”, per Caltrans Standard Plan ES-5B unless indicated otherwise on the plans.

Type A Detector Handholes shall be installed along the edge of the paved road prior to the loops being routed under existing curb gutter and sidewalk improvements.

Each cable shall be identified in the pull-box nearest the loop and in the controller cabinet as to its “phase and loop number”.

Conductors to be buried in the pavement shall be installed only in the presence of the Engineer. All loops shall be connected in series. All loops shall be installed prior to final lift of asphalt pavement.

“Overcoat Loop Filler”, or approved equal, shall be used to install the detector loops. Epoxy shall not be used except in concrete surfaces. Asphalt concrete shall be used to fill all curb termination points.

SP28-02 MEASUREMENT AND PAYMENT

The contract price paid per each for “**Vehicle Detector Loops**” shall be considered full compensation for furnishing all labor, materials, tools, equipment and incidentals, including all necessary saw cutting, splicing, and connections, and for doing all work involved in installing new functional vehicle detector loops in coordination with final paving as shown on the plans, as specified in these Special Provisions, and as directed by the Engineer; and no additional compensation shall be allowed therefor

APPENDIX A
STANDARD PLANS

COUNTY ROUTE PROJECT SHEET NO. 1 SHEETS
 REGISTERED CIVIL ENGINEER
 MAY 20, 2011
 PLANS APPROVAL DATE
 THE STATE OF CALIFORNIA BY ITS OFFICE OF PUBLIC WORKS
 CONTRACT NO. 13-03-115
 PROJECT NO. 13-03-115
 CONTRACT NO. 13-03-115
 PROJECT NO. 13-03-115

NO PASSING ZONES-TWO DIRECTION

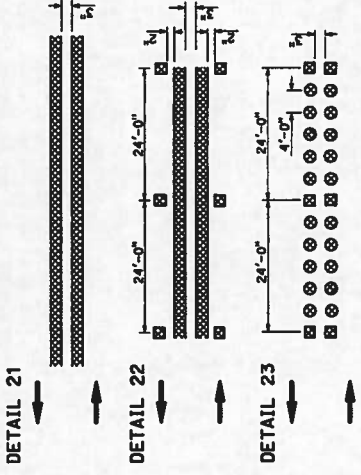

LANELINES (CONT)
(MULTILANE HIGHWAYS)

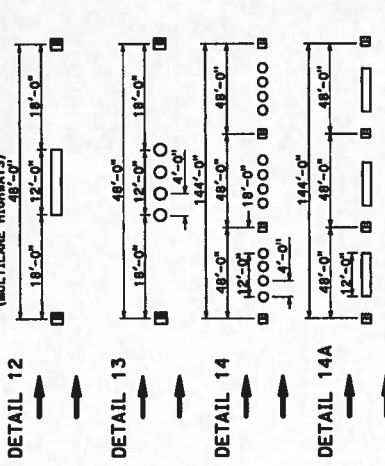

CENTERLINES
(2 LANE HIGHWAYS)

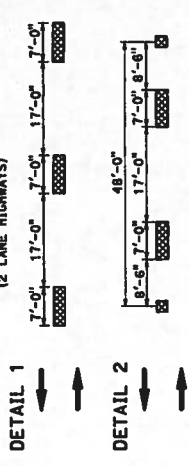

NO PASSING ZONES-ONE DIRECTION

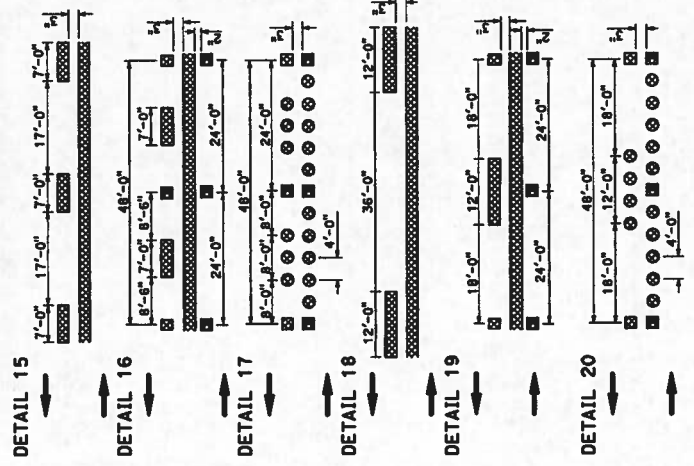

LANELINES
(MULTILANE HIGHWAYS)

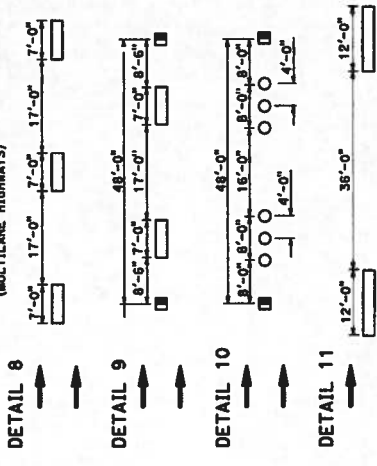

TYPICAL LANE LINE DELINEATION IN ADVANCE OF EXIT RAMP

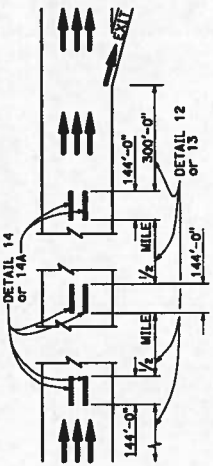

- LEGEND**
- TYPE A WHITE NON-REFLECTIVE
 - ⊙ TYPE AY YELLOW NON-REFLECTIVE
 - ⊛ TYPE C RED-CLEAR RETROREFLECTIVE
 - ⊞ TYPE D TWO-WAY YELLOW RETROREFLECTIVE
 - ⊠ TYPE G ONE-WAY CLEAR RETROREFLECTIVE
 - ⊡ TYPE H ONE-WAY YELLOW RETROREFLECTIVE
- MARKERS**
- 4" WHITE
 - ⊞ 4" YELLOW
- LINES**
- DIRECTION OF TRAVEL

NOTES

Detail 14 is to be used in combination with Detail 13. Detail 14A is to be used in combination with Detail 12.

MARKER DETAILS

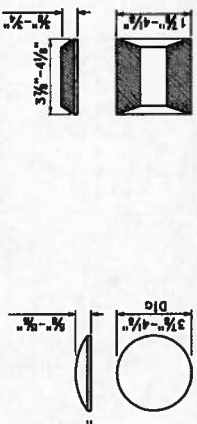

RETROREFLECTIVE FACE



STATE OF CALIFORNIA
 DEPARTMENT OF TRANSPORTATION
PAVEMENT MARKERS AND TRAFFIC LINES TYPICAL DETAILS
 NO SCALE

A20A

DIST	COUNTY	ROUTE	TOTAL PROJECT	SHEET NO.	TOTAL SHEETS

MAY 20, 2011
 REGISTERED CIVIL ENGINEER
 STATE OF CALIFORNIA
 LICENSE NO. 37113
 EXPIRES 5/20/13
 THE STATE OF CALIFORNIA OR ITS OFFICERS OR EMPLOYEES SHALL NOT BE RESPONSIBLE FOR THE CONSEQUENCES OF THE USE OF THIS PLAN SHEET.

LEGEND

MARKERS

- TYPE AY YELLOW NON-REFLECTIVE
- TYPE D TWO-WAY YELLOW RETROREFLECTIVE
- TYPE H ONE-WAY YELLOW RETROREFLECTIVE

LINES

- 4" WHITE
- 4" YELLOW

DIRECTION OF TRAVEL

MEDIAN ISLANDS

DETAIL 28

LEFT EDGELINES (DIVIDED HIGHWAYS)

DETAIL 24

DETAIL 25

DETAIL 25A

DETAIL 26

DETAIL 27

RIGHT EDGELINES

DETAIL 27A

DETAIL 27B

INTERSECTION TREATMENTS

DETAIL 34

DETAIL 34A

DETAIL 35

DETAIL 35A

TWO-WAY LEFT TURN LANES

DETAIL 31

RIGHT EDGELINE EXTENSION THROUGH INTERSECTIONS

DETAIL 27C

MARKER DETAILS

TYPE AY

TYPE D

TYPE H

RETROREFLECTIVE FACE

STATE OF CALIFORNIA
DEPARTMENT OF TRANSPORTATION

PAVEMENT MARKERS AND TRAFFIC LINES TYPICAL DETAILS

NO SCALE

A20B

DIST COUNTY ROUTE TOTAL PROJECT SHEET NO. PROJECT NAME

REGISTERED CIVIL ENGINEER
 MAY 20, 2011
 STATE OF CALIFORNIA
 THE STATE OF CALIFORNIA DOES HEREBY CERTIFY THAT THE ABOVE ENGINEER IS A LICENSED PROFESSIONAL ENGINEER IN THE STATE OF CALIFORNIA.

RECESSED MARKER NOTES:

- See typical traffic line details for marker patterns to be used with recessed pavement markers. This requires a Type 2 recess.
- The retroreflective pavement marker installations are not to be used for non-recessed installations. The top of pavement markers installed in recesses shall be 0 to 1/8" below the pavement surface.

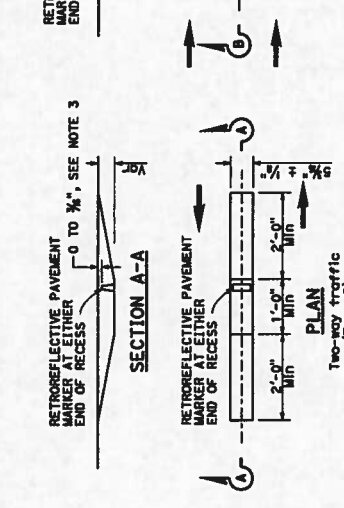

RECESS DETAIL FOR RETROREFLECTIVE PAVEMENT MARKER

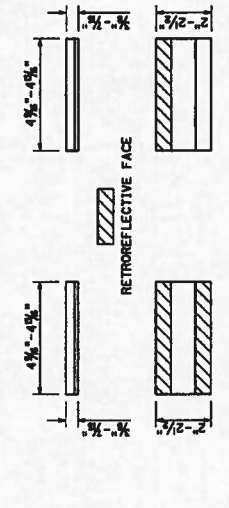

STATE OF CALIFORNIA
 DEPARTMENT OF TRANSPORTATION
**PAVEMENT MARKERS
 AND TRAFFIC LINES
 TYPICAL DETAILS**
 NO SCALE

A20D

LEGEND MARKERS

- TYPE A WHITE NON-REFLECTIVE
- ⊙ TYPE AY YELLOW NON-REFLECTIVE
- ◻ TYPE G ONE-WAY CLEAR RETROREFLECTIVE
- ▨ 4" YELLOW LINE
- DIRECTION OF TRAVEL

MARKER DETAILS

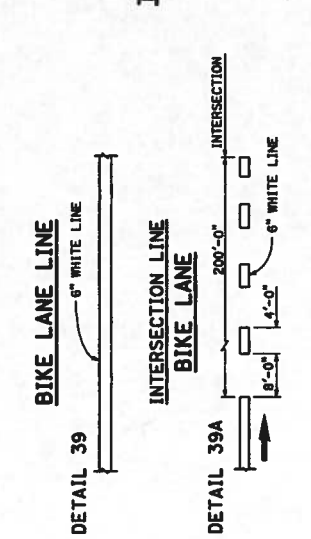
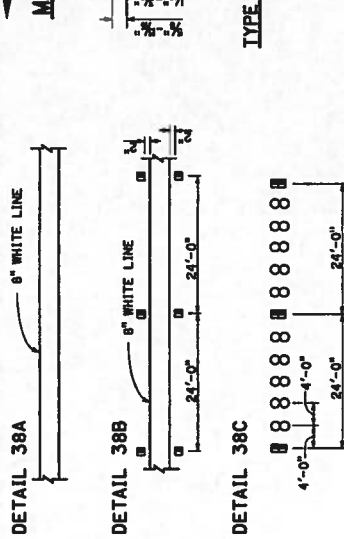
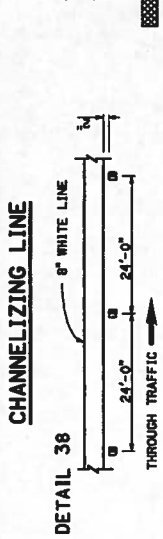
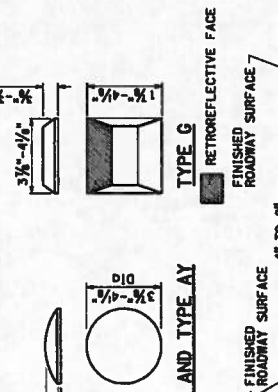

DIST#	COUNTY	ROUTE	POST MILES	SHEET NO.	TOTAL SHEETS

REGISTERED CIVIL ENGINEER
 REGISTERED PROFESSIONAL ENGINEER
 STATE OF CALIFORNIA
 LICENSE NO. 32313
 EXPIRES 3-31-13

MAY 20, 2011
 PLEASE APPROVAL DATE
 THESE DRAWINGS SHALL BE REVIEWED FOR
 PROJECT OF THIS AGENCY.

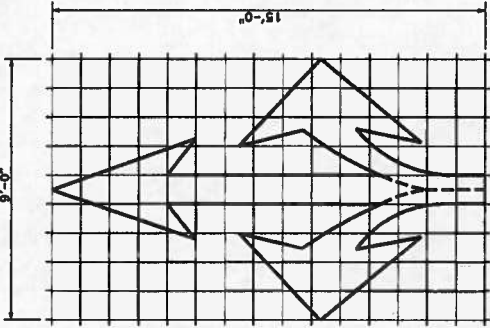

TYPE VIII ARROW
 A=36 f12

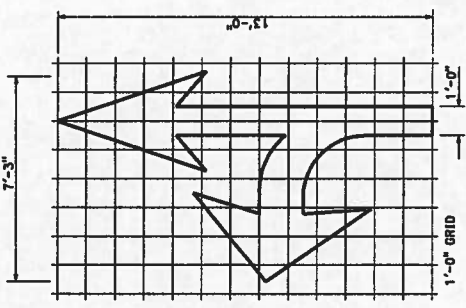

TYPE VIII (L) ARROW
 A=27 f12
 (For Type III (R) arrow, use mirror image)

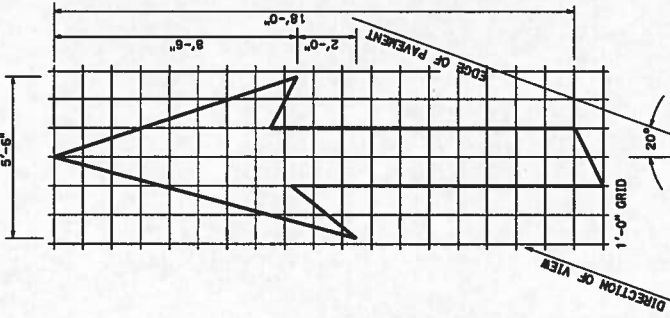

TYPE IX ARROW
 A=42 f12
 Right lane drop arrow
 (For left lane, use mirror image)

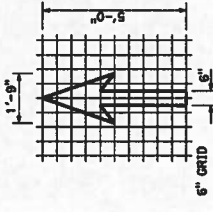

BIKE LANE ARROW
 A=7 f12

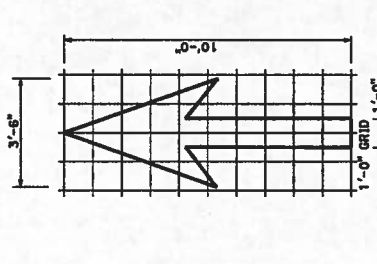

TYPE I 10'-0" ARROW
 A=14 f12

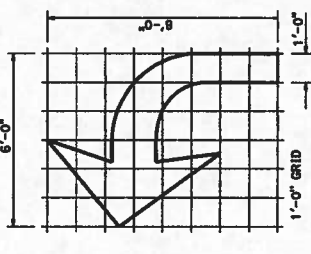

TYPE IV (L) ARROW
 A=15 f12
 (For Type II (R) arrow, use mirror image)

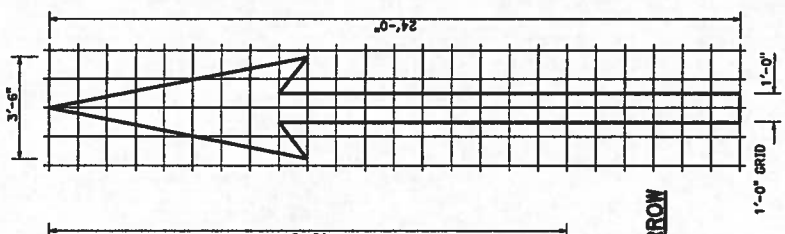

TYPE I 24'-0" ARROW
 A=31 f12

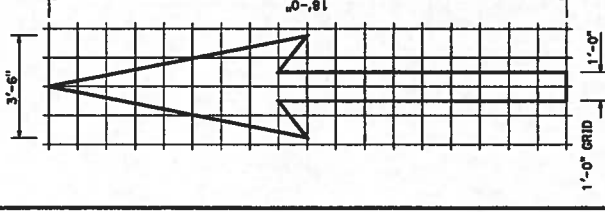

TYPE I 18'-0" ARROW
 A=25 f12

NOTE:
 Minor variations in dimensions may be accepted by the Engineer.

STATE OF CALIFORNIA
 DEPARTMENT OF TRANSPORTATION
**PAVEMENT MARKINGS
 ARROWS**
 NO SCALE

A24A

DIST	COUNTY	ROUTE	SHEET NO.	TOTAL SHEETS

REGISTERED CIVIL ENGINEER
 REGISTERED PROFESSIONAL LAND SURVEYOR
 STATE OF CALIFORNIA
 No. 32313
 EXPIRES 12/31/13

MAY 20, 2011
 DATE OF EXPIRATION OF THIS LICENSE
 THIS LICENSE IS VALID FOR THE STATE OF CALIFORNIA ONLY AND IS NOT VALID FOR ANY OTHER STATE OR COUNTRY.
 THIS LICENSE IS NOT VALID FOR THE STATE OF CALIFORNIA IF THE LICENSEE HAS BEEN CONVICTED OF ANY FELONY OR Misdemeanor IN THE LAST 10 YEARS.

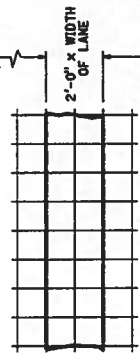
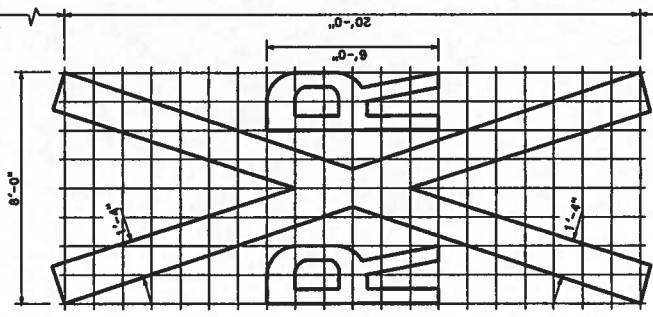
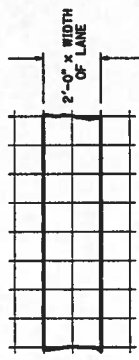

RAILROAD CROSSING SYMBOL
 1'-0" GRID
 A=70 f+2 *

* 70 f+2 does not include the 2'-0" x variable width transverse lines.

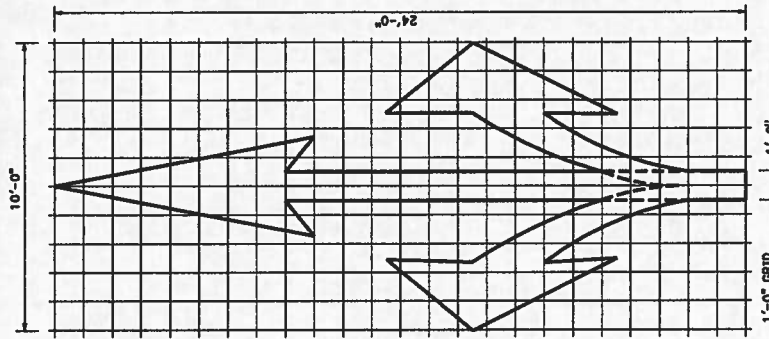

TYPE I (B) ARROW
 A=59 f+2

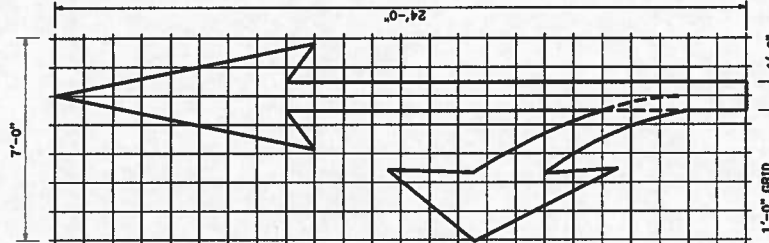

TYPE I (L) ARROW
 A=45 f+2
 (For Type I (R) use mirror image)

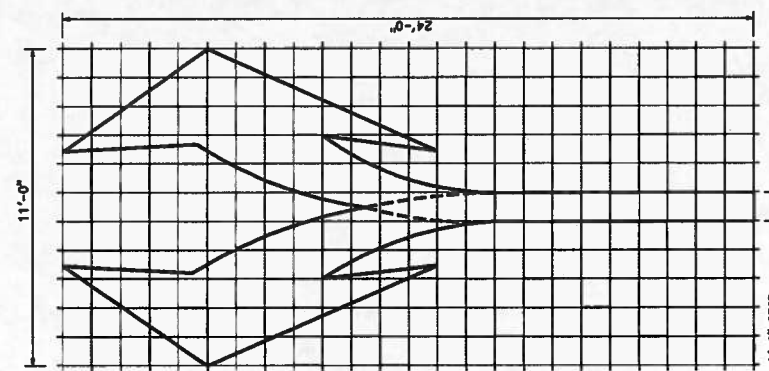

TYPE III (B) ARROW
 A=73 f+2

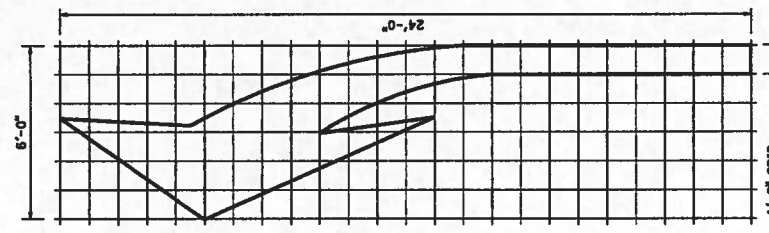

TYPE III (L) ARROW
 A=42 f+2
 (For Type III (R) use mirror image)

NOTE:
 Minor variations in dimensions may be accepted by the Engineer.

STATE OF CALIFORNIA
 DEPARTMENT OF TRANSPORTATION

**PAVEMENT MARKINGS
 ARROWS AND SYMBOLS**

NO SCALE

A.24B

Sheet COUNTY ROUTE TOTAL PROJECT SHEET TOTAL SHEETS

REGISTERED CIVIL ENGINEER
 REGISTERED PROFESSIONAL ENGINEER IN CIVIL ENGINEERING
 STATE OF CALIFORNIA
 EXPIRES 12/31/11
 32-31-11

MAY 20, 2011
 PLEASE APPROVAL DATE
 THE STATE SHALL NOT BE RESPONSIBLE FOR THE ACCURACY OR COMPLETENESS OF PLANS DRAWN BY THIS FIRM SHEET.

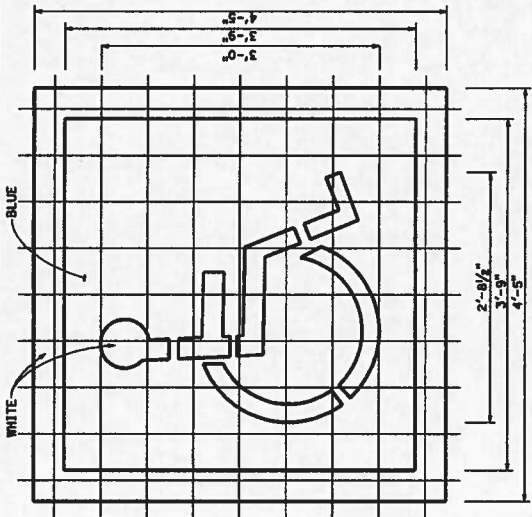

INTERNATIONAL SYMBOL OF ACCESSIBILITY (ISA) MARKING

6" GRID
 A (WHITE) = 9 ft x 2
 A (BLUE) = 14 ft x 2

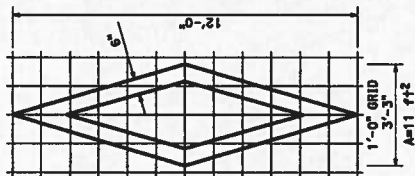

DIAMOND SYMBOL

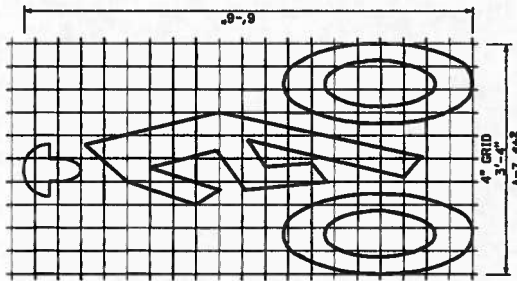

BIKE LANE SYMBOL WITH PERSON

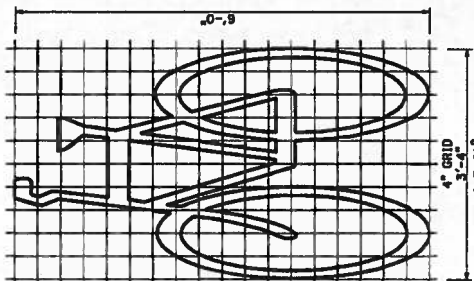

BIKE LANE SYMBOL WITHOUT PERSON

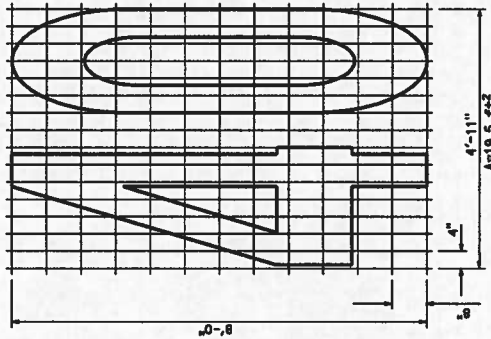

NUMERALS

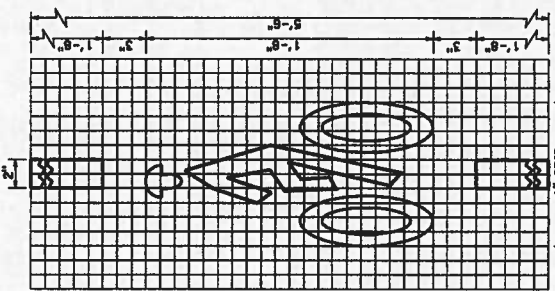
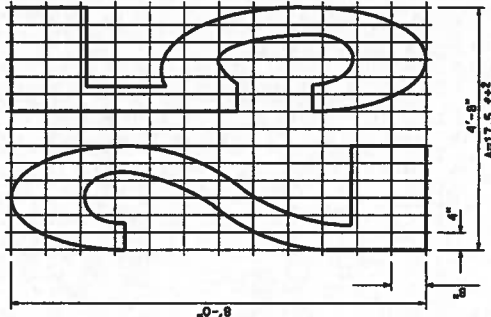
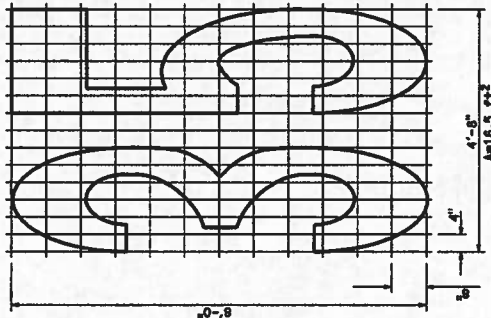

BIKE LOOP DETECTOR SYMBOL

NOTE:
 Minor variations in dimensions may be accepted by the Engineer.

STATE OF CALIFORNIA
 DEPARTMENT OF TRANSPORTATION
PAVEMENT MARKINGS SYMBOLS AND NUMERALS
 NO SCALE
A24C

DIST.	COUNTY	ROUTE	POST MILE	SECTION

REGISTERED CIVIL ENGINEER
R. J. Smith, Jr.
 MAY 20, 2011
 EXPIRES: MAY 20, 2014
 LICENSE NO. 45879
 STATE OF CALIFORNIA
 REGISTERED CIVIL ENGINEER

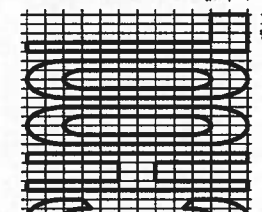
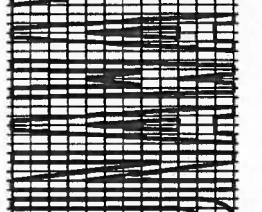
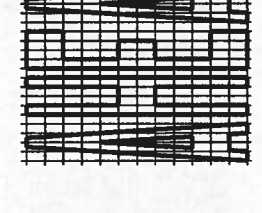
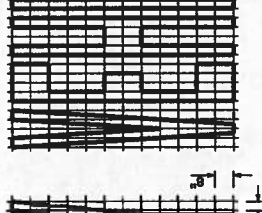
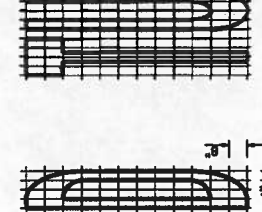
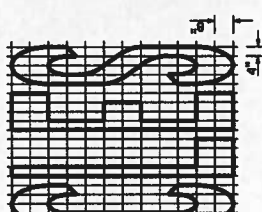
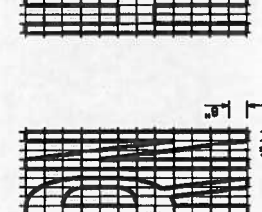
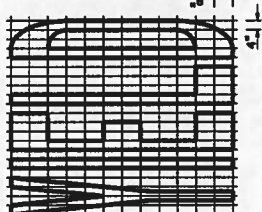
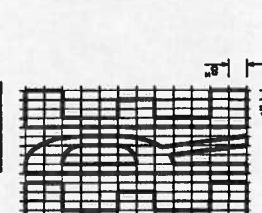
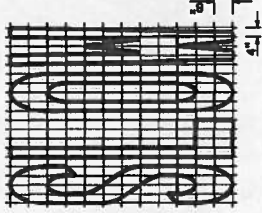
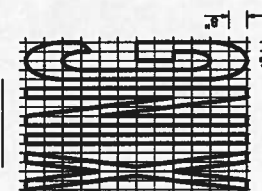
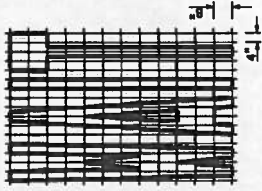

NOTES

1. If a message consists of more than one word, it should read "up", i.e., the first word should be nearest the driver.
2. The space between words should be at least four times the height of the characters for low speed roads, but not more than ten times the height of the characters. The space may be reduced appropriately where there is limited space because of local conditions.
3. Minor variations in dimensions may be accepted by the Engineer.
4. Portions of a letter, number or symbol may be separated by connecting segments not to exceed 2" in width.

WORD MARKINGS

ITEM	ft+2	ITEM	ft+2	ITEM	ft+2		
XING	21	YIELD	24	BIKE	5	PEDEST	18
AHEAD	51	SCHOOL	35	SLOW	23	COMPACT	10
LANE	19	SIGNAL	32	STOP	22	REURWAY	43
RIGHT	25	TURN	24	LEFT	19	VEHICLES	42
		HERE	26				

STATE OF CALIFORNIA
 DEPARTMENT OF TRANSPORTATION

**PAVEMENT MARKINGS
 WORDS**

NO SCALE

A24D

DIST. COUNTY ROUTE MILE PROJECT SHEET TOTAL SHEETS
 REGISTERED CIVIL ENGINEER
 MAY 20, 2011
 PLANS APPROVAL DATE
 THE STATE SHALL NOT BE RESPONSIBLE FOR THE ACCURACY OF THE INFORMATION CONTAINED HEREIN.
 REGISTERED PROFESSIONAL ENGINEER IN THE STATE OF CALIFORNIA
 EXPIRES 12-31-13

ITEM	FT+2	ITEM	FT+2
LANE	24	NO	14
POOL	25	BIKE	21
CAR	17	BUS	20
CLEAR	27	ONLY	22
KEEP	24	FWY	16

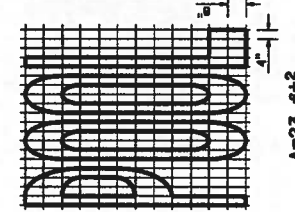
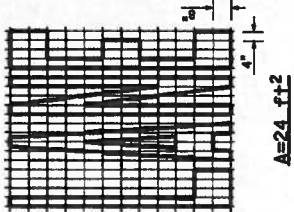
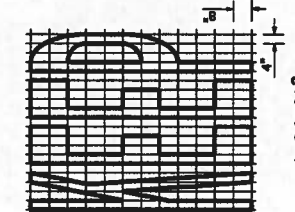
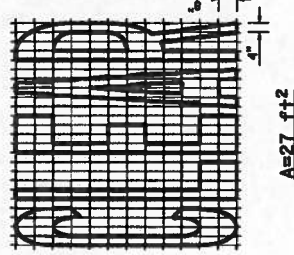
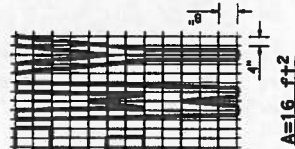
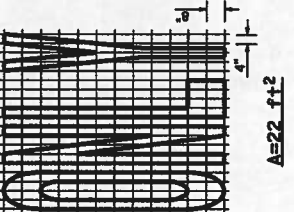

- NOTES:**
- If a message consists of more than one word, it should read "up", i.e., the first word should be nearest the driver.
 - The space between words should be at least four times the height of the letters on speed roads, but not more than ten times the height of the characters on other roads. The spacing should be appropriately varied where there is limited space because of local conditions.
 - Minor variations in dimensions may be accepted by the Engineer.
 - Portions of a letter, number or symbol may be separated by connecting segments not to exceed 2" in width.
 - Crosswalks contiguous to school grounds are to be 1'-0" yellow lines in place of 1'-0" white lines.
 - The words "NO PARKING" pavement marking is to be used for parking facilities. For typical locations of markings, see Standard Plans A90A and A90B.
 - The words "NO PARKING" shall be painted in white letters no less than 1'-0" high on a contrasting background and located so that it is visible to traffic enforcement officials.



CROSSWALK AND LIMIT LINE
See Note 5

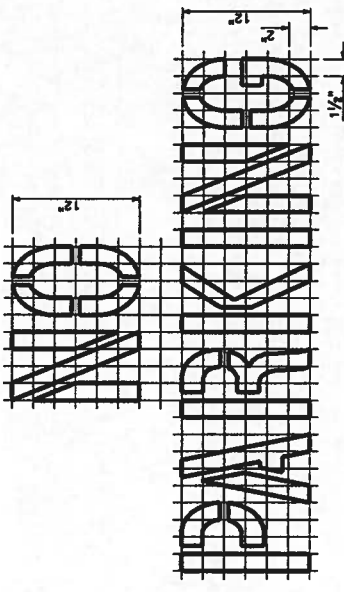
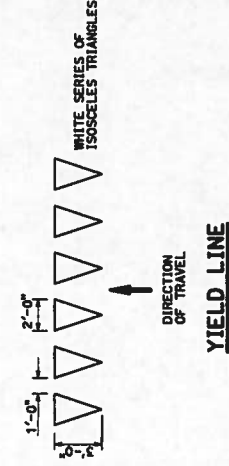

STATE OF CALIFORNIA
DEPARTMENT OF TRANSPORTATION

**PAVEMENT MARKINGS
WORDS AND CROSSWALKS**
NO SCALE

A24E

REGISTERED PROFESSIONAL ENGINEER
 MAURICE M. SHUL
 No. 232042
 CIVIL
 Exp. 12/31/07

PUBLIC WORKS DIRECTOR
 6/12/07
 PLANS APPROVAL DATE

The County of Contra Costa is the owner of this plan and the engineer or architect shall not be responsible for the accuracy or completeness of electronic copies of this plan sheet.

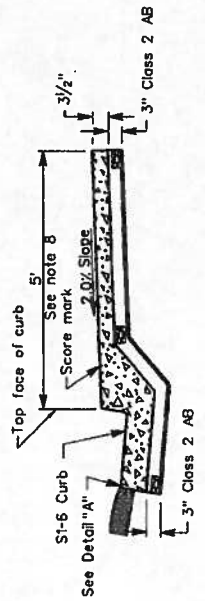
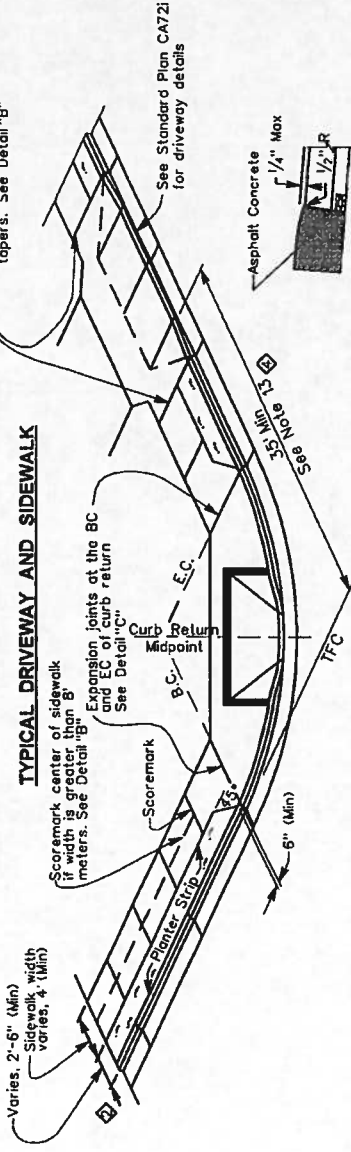
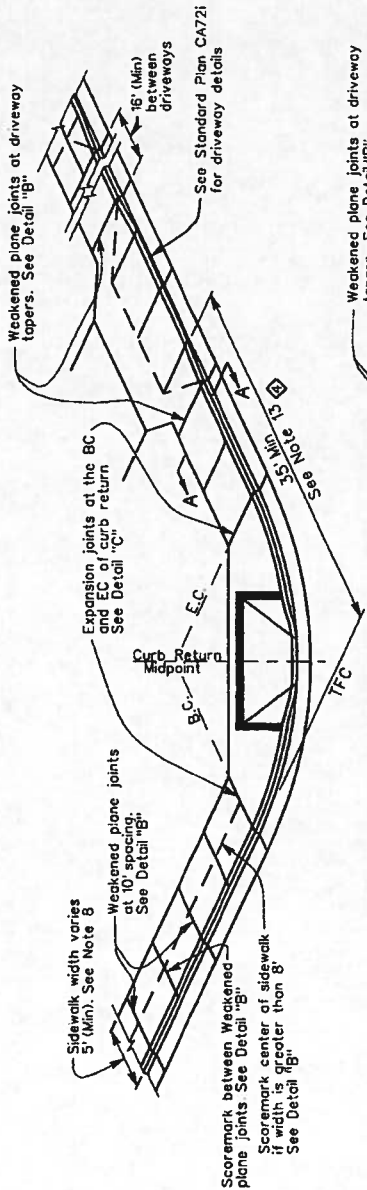

NOTES:

- Class 3 Portland Cement Concrete (505 lb PC per cubic yard, 1" maximum aggregate) shall be used for all construction detailed on this plan. New curb and adjoining sidewalk shall be constructed monolithically.
- Transverse scoremarks shall be made at 10' intervals on the sidewalk (including the portion in the driveway area) and longitudinal scoremarks shall be made along the centerline of any sidewalk which is 8' or more in width. Weakened plane joints shall be provided at 10' intervals in curb and sidewalk (including the portion in the driveway area) See Detail "B" and "Typical Sidewalk Detail".
- Curb reference stakes shall not be offset more than 3' from the back of curb or more than 2' from the back of the sidewalk.
- Where there is a planter strip between the sidewalk and the curb, the curb in a driveway depression shall be constructed monolithically with the driveway.
- When the street slopes away from a curb, the gutter slope shall match the cross slope of the street.
- Paving at the gutter lip shall conform to "Detail A" except when the street slopes away from the curb, the paving shall match the gutter lip.
- Meter boxes, poles, and fire hydrants locations shall conform to locations shown on Standard Plan CU601.
- Minimum sidewalk widths are 5'-0" for residential; 6'-6" for multiple zoned; 10'-0" for retail business and commercial areas; 8'-0" in retail and commercial areas where right of way is limited.
- A 3" layer of Class 2 aggregate base or subbase shall be placed under all curb and sidewalk sections unless otherwise noted.
- Expansion joint "Detail C" shall be installed at the BC and EC of all returns and the back of sidewalk at driveways.
- See Standard Plan CA711 for curb details.
- Premolded joint filler material for expansion joints shall conform to Section 51-1.12C "Premolded Expansion Fillers," of the State Standard Specifications.
- 35' is the minimum offset on low volume, low speed residential streets. For higher volume, higher speed roads, the 35' dimension shall increase to comply with Topic 405, "Intersection Design Standards", 405.1 Sight Distance of the California Department of Transportation, Highway Design Manual.

NO.	DATE	REVISION DESCRIPTION	BY
2-02		Supersedes Standard Plan CA70	P.W.
	dated 11-99		
6-02		Revised Dimension	HH
7-02		Concrete Spec. Revision	HH
4-07		Driveway Location	HH
4-07		Change in plan reference number	HH

COUNTY OF CONTRA COSTA
 PUBLIC WORKS DEPARTMENT
 MARTINEZ, CALIFORNIA
 STANDARD PLAN

STANDARD SIDEWALK DETAILS

SCALE: NO. SCALE
 DRAWN BY: H.HUSSEY
 DATE: 4-07
 PLAN NO. CA701
 CHECKED BY: M.HOLMSWORTH

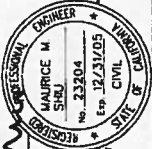

Maurice M. Shuj
 PUBLIC WORKS DIRECTOR
 PLANS APPROVAL DATE: 11/27/2002
 The County of Contra Costa or its officers or agents shall not be responsible for the accuracy or completeness of electronic copies of files from a server.

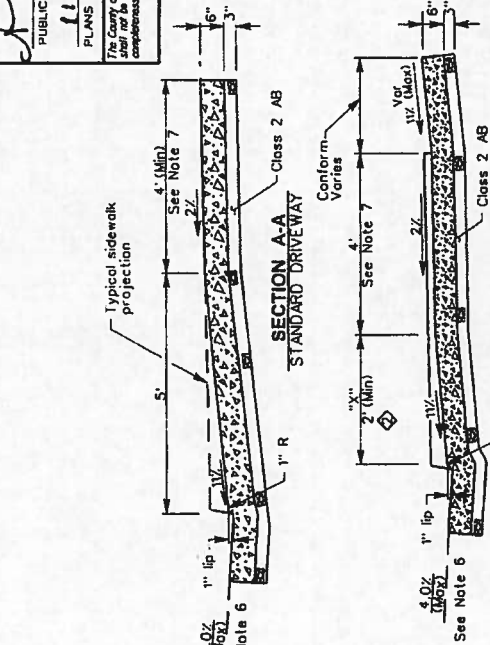

NOTES:
 SECTION A-A STANDARD DRIVEWAY See Note 4
 SECTION B-B MODIFIED DRIVEWAY See Note 4

- 1 New depressed curb and driveway ramps shall be constructed monolithically.
- 2 The modified driveway may be used when approved by the Public Works Department. "X" shall be as large as possible.
- 3 Retaining curbs and driveway conforms as required by the Public Works Department.
- 4 For depressed driveways (section B-B) the sidewalk shall be a minimum of 3/8" (1"x2") above the gutter flowline grade. Depth of gutter flows shall be calculated and compared to proposed depressed sidewalk elevations during design.
- 5 See Standard Plan CA70i for weakened plane joint expansion joint, and scoremark details.
- 6 If pavement cross slope exceeds 4.0%, the modified driveway shall be used with the slope of the driveway ramp reduced such that the difference in slope of the driveway ramp and the slope of a line between the gutter and a point on the roadway 5' from gutter flowline shall not exceed 1/2". Reduced driveway slope shall be approved by the Public Works Department.
- 7 Minimum width of clear passage shall be 4' with a 2% cross slope. Where right of way restrictions, natural barriers or other restrictions create an unreasonable hardship, the clear width may be reduced to 3' with a 2% cross slope, with approval of the Public Works Department.
- 8 Acquisition of construction easement may be necessary where right of way is limited to construct conform.
- 9 Dimension is 18" for a sidewalk width of 4', 23" for a sidewalk width of 5', and 14" for a sidewalk width of 3'.

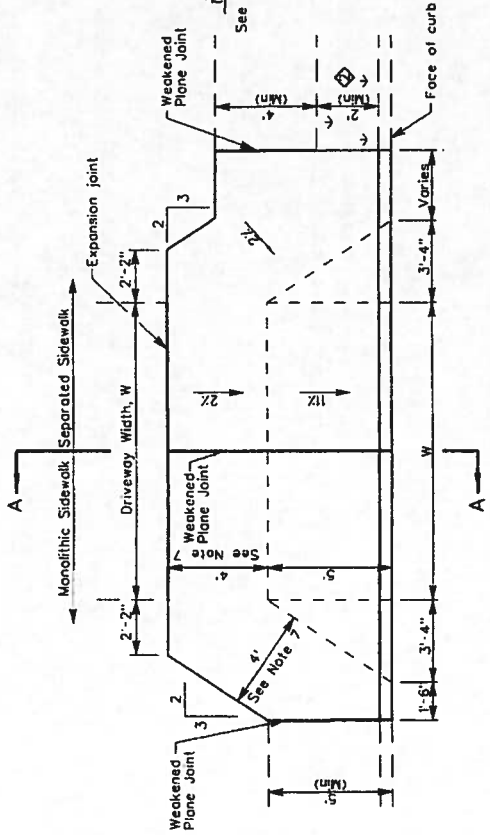

STANDARD DRIVEWAY RAMP

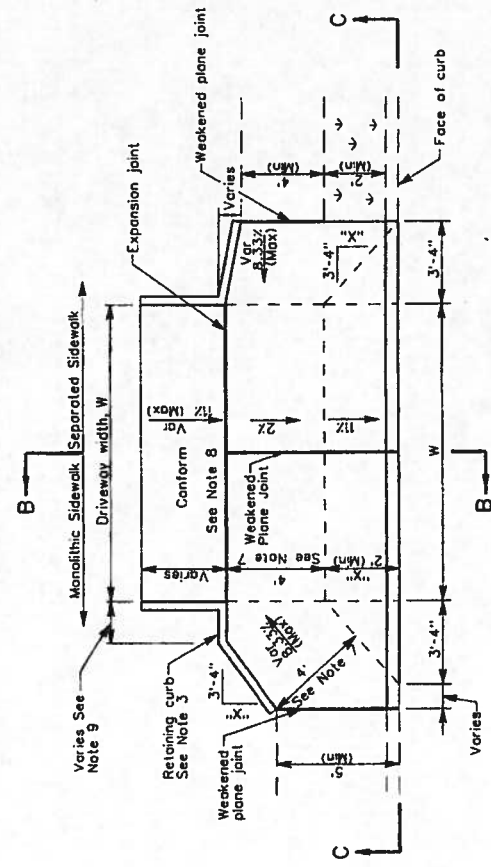

MODIFIED DRIVEWAY RAMP
 See Note 2

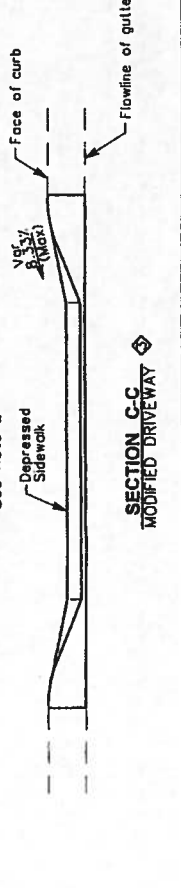

SECTION C-C MODIFIED DRIVEWAY

COUNTY OF CONTRA COSTA
 PUBLIC WORKS DEPARTMENT
 MARTINEZ, CALIFORNIA
 STANDARD PLAN

DRIVEWAY RAMP DETAILS

SCALE: NO. SCALE: P.W. DATE: 2-02
 DRAWN BY: H.AUSSEY PLAN NO: CA72i
 CHECKED BY: M. HOLLINGSWORTH

NO.	DATE	REVISION DESCRIPTION	BY
2-02		Supersedes Standard Plan CA72 dated 11-99	P.W.
5-02		Revised Dimension 3' to 2' & insetwork	HH
B-02		Added Section C-C	P.W.

APPENDIX B

**WASTE MANAGEMENT PLAN
AND
WASTE ASSESSMENT FORM**

Special Provisions

WASTE ASSESSMENT FORM

(To be filled out and submitted to the Engineer before commencing demolition work)

The table below lists debris materials that are routinely generated during construction or demolition. Identify the materials that you estimate will be recycled, salvaged, or landfilled from your project site and the handling procedure, hauler and/or destination of each material type.

Material Type	Identify Materials (I)			Handling Procedure, Hauler, or Final Destination of Material
	Recycle	Salvage	Landfill	
Asphalt				
Brick				
Concrete				
Dirt/Clean Fill				
Masonry				
Metals (steel, brass, aluminum, copper, etc.)				
Rock/Stone				
Vegetative Debris				
Wood/Lumber				
Other:				
Garbage				

Please sign and date attesting that the above information is true and correct to the best of your knowledge, that you acknowledge that 40% of your contract retention may be forfeited to the City for failure to meet the 50 percent diversion requirement, and that you are responsible for the actions of your subcontractors or other agents with regard to the diversion requirement.

CONTRACTOR NAME: _____

SIGNATURE: _____ DATE: _____

Special Provisions

WASTE ASSESSMENT SUMMARY REPORT FORM

(To be filled out upon project completion)

Complete the table below by indicating what was actually done with all the C&D materials from the project and the quantities (by weight) that were recycled, salvaged, or landfilled. All C&D materials must be accounted for whether or not they were recycled or taken to the landfill. Attach receipts and weight tags from all recyclers and landfill locations identifying, 1) date, 2) project number, 3) material type, 4) if materials were recycled, salvaged, or landfilled, and 5) weight of load(s).

Material Type	Identify Materials (lb)			Handling Procedure, Hauler, or Final Destination of Material
	Recycle	Salvage	Landfill	
Asphalt				
Brick				
Concrete				
Dirt/Clean Fill				
Masonry				
Metals (steel, brass, aluminum, copper, etc.)				
Rock/Stone				
Vegetative Debris				
Wood/Lumber				
Other:				
Garbage				

Please sign and date attesting that the above information is true and correct to the best of your knowledge, that you acknowledge that 40% of your contract retention may be forfeited to the City for failure to meet the 50 percent diversion requirement.

CONTRACTOR NAME: _____

SIGNATURE: _____ DATE: _____

Special Provisions

RECEIPT FOR MATERIALS RECYCLED

(To be filled out by receiver only if facility does not issue an itemized receipt)

Company or Individual Receiving Material: *(Business stamp is acceptable)*

Company:			
Address:			
City:			
Zip:			
Phone:			
Facility/Individual Type: <i>(Circle one)</i> Recycler Salvager End User			
Facility Attendant Signature: <i>(Required)</i>			

Construction/Demolition Company: *(Business stamp is acceptable)*

Company:	
Address:	
City:	
Zip:	
Phone:	Contact:

Materials Received:

Material Type	Amount <i>(specify in cubic yards, lbs, or tons)</i>	Cost <i>(or payment if applicable to service)</i>	Intended Use of Material Received <i>(circle one)</i>	Date Received or Picked Up
			Recycle Reuse Salvage Landfill	
			Recycle Reuse Salvage Landfill	
			Recycle Reuse Salvage Landfill	
			Recycle Reuse Salvage Landfill	

Thank you for recycling.

APPENDIX C

STAGING AREA LOCATION AND LIMITS

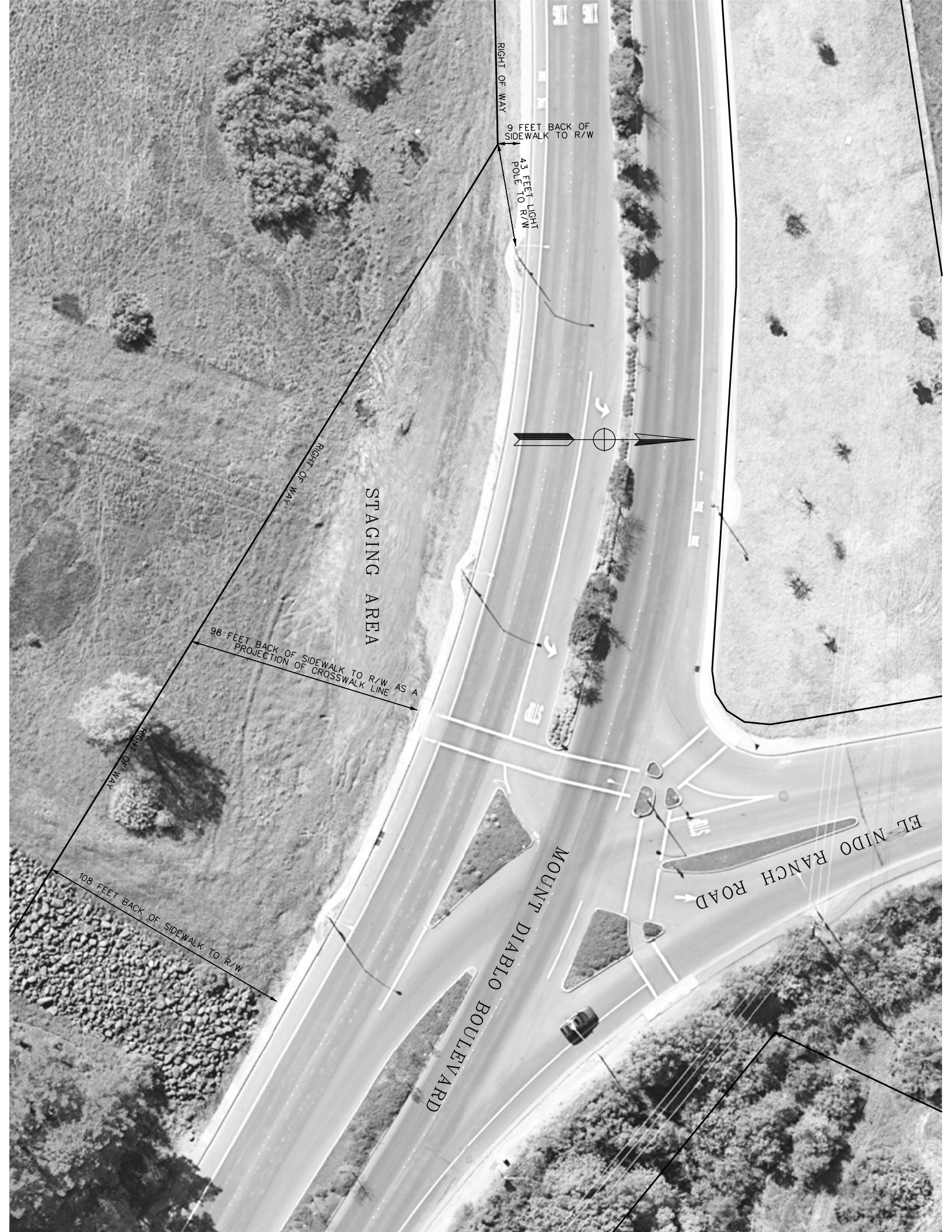

RIGHT OF WAY

9 FEET BACK OF SIDEWALK TO R/W

43 FEET LIGHT POLE TO R/W

STAGING AREA

RIGHT OF WAY

98 FEET BACK OF SIDEWALK TO R/W AS A PROJECTION OF CROSSWALK LINE

RIGHT OF WAY

108 FEET BACK OF SIDEWALK TO R/W

MOUNT DIABLO BOULEVARD

EL NIDO RANCH ROAD



APPENDIX E

RESIDENT NOTIFICATION LETTERS

- Letter #1 -- Chip Seal Only Streets
- Letter #2 -- Cape and Slurry Seal Streets



City Council

Mike Anderson, Mayor
Don Tatzin, Vice Mayor
Brandt Andersson, Council Member
Mark Mitchell, Council Member
Traci Reilly, Council Member

Dear Resident:

_____, under contract with the City of Lafayette, will be performing stop-gap maintenance repairs on your street. This work will be done in two distinct phases. Please see work schedule on the back of this notice indicating what work is scheduled for your street. The hours of construction will be from 8:00 AM to 5:00 PM, Monday through Friday. This work will be done in two distinct phases. The first will consist of filling potholes and placing a layer of "skin patch" pavement over major depressions in the road. This will be followed by a chip seal where a mat of rubberized liquid asphalt and half-inch rock chips will be applied to the entire road surface. The treatment is intended to fill the existing cracks in the street and provide a new wearing surface, thereby preserving the existing condition of the road until such time when it can be reconstructed. Please be aware that this is not a resurfacing of the road, and the finished surface will have a rough texture and may have a salt and pepper appearance. Existing dips and undulations in the driving surface will likely remain after the treatment.

In order to provide the City and its residents with a better looking and longer lasting road, as well as provide the workers with a safe work environment, we ask that traffic closures be observed. During the pothole and skin patch phase of work the streets will be open to traffic, however, on street parking will not be permitted. During the chip seal process the roads will be closed to traffic for approximately 2 hours. Access to properties will be restricted during this time as non-emergency vehicles will not be permitted to drive across or on the wet slurry. The City will make arrangements for access by emergency vehicles. **Please note that if you live off a street that will receive a chip or slurry seal treatment your access will also be restricted.** In the few days immediately following the chip seal, signs will be posted to advise motorists to reduce speed to avoid kicking up the loose rock chips that would be expected on the roadway.

Barricades and traffic cones will be placed to prevent vehicles from entering the wet areas. Please do not go around the traffic control devices; chip seal is a tar-like substance that can splash onto the sides of vehicles as well as track onto other surfaces such as driveways and sidewalks if driven through or walked upon while wet. If you do have oil on something, simple dish soap and water will clean the area if caught before the oil has had time to dry. Otherwise we recommend a citrus solvent-type cleaner.

Notification and no parking signs will be placed on the road a minimum of 3 days prior to the start of each phase of work. These signs will provide the roadwork dates when parking on the street will not be allowed. It is very important that our contractor's crews have access to the entire street. Please note that vehicles parked on the street blocking construction activities will be towed at the owners' expense. In order to sweep excess loose rocks after placement, we request that you park off the chip-sealed streets for two days following the placement of the chip seal.

In the event the contractor is unable to perform chip or slurry seal work on your street on the scheduled day project information signs at the entrance to your street will be updated to provide the new date and times for the work.

If you have any questions regarding these access restrictions, please contact me at (925) 299-3247.

Sincerely,
Matt Luttrupp, Associate Engineer City of Lafayette

Street	Pavement Repairs	Chip Seal
Woodside Court Glorietta Boulevard to End		
Old Millstone Lane Las Huertas Road to End		
Anita Court Janet Lane to End		
Warner Court Springbrook Road		
East Terrace Springbrook Road		
Glenside Circle Glenside Drive to Glenside Drive		
Sharon Court Burton Drive to End		
Gold Court Burton Drive to End		
Antonio Court Lucas Drive to End		
Lucas Circle Lucas Drive to End		
Lancaster Drive Lucas Drive to Somerset Drive		
Crofton Court Lancaster Drive to End		
Kingsley Place Somerset Drive to End		
West Lowell Lane Silverado Drive to End		
Marsha Place Silverado Drive to End		
Silverado Drive Bradbury Drive to End		
McBride Drive (North) Bradbury Drive to End		
Green Acres Court McBride to End		
McBride Drive (South) Bradbury Drive to End		
Ruppel Place Bradbury Drive to End		



City Council

Mike Anderson, Mayor
Don Tatzin, Vice Mayor
Brandt Andersson, Council Member
Mark Mitchell, Council Member
Traci Reilly, Council Member

Dear Resident:

_____, under contract with the City of Lafayette, will be performing maintenance repairs on your street. This work will be done in one to four distinct phases, depending on the design treatment for your street. Please see work schedule on the back of this notice indicating what work is scheduled for your street. Please note that not all streets will receive all four of the pavement preservation treatments (please see the schedule on the back of this page for additional information regarding the work scheduled for your street). The hours of construction will be from 8:00 AM to 5:00 PM, Monday through Friday. Work will begin with patch paving and crack sealing to address localized areas of pavement defects. On some streets a chip seal will then follow to place a mat of rubberized liquid asphalt and rock chips to blanket the entire road surface. Lastly some streets will receive the slurry seal application. Please note that the slurry seal can take up to 4 or 5 hours to dry sufficiently to allow cars to drive on it.

In order to provide the City and its residents with a better looking and longer lasting road, as well as provide the workers with a safe work environment, we ask that traffic closures be observed. During the pavement repair and crack seal phases of work the streets will be open to traffic, however, on street parking will not be permitted. During the chip seal process the roads will be closed to traffic for approximately 2 hours. During the slurry seal process the streets, except School Street and Toper Lane, will be closed to traffic for a period of up to 5 hours. Access to properties will be restricted during this time as non-emergency vehicles will not be permitted to drive across or on the wet slurry. The City will make arrangements for access by emergency vehicles. In the few days immediately following the chip seal, signs will be posted to advise motorists to reduce speed to avoid kicking up the loose rock chips that would be expected on the roadway. **Please note that if you live off a street that will receive a chip or slurry seal treatment your access will also be restricted.**

Barricades and traffic cones will be placed to prevent vehicles from entering the wet areas. Please do not go around the traffic control devices; chip and slurry seal are tar-like substances that can splash onto the sides of vehicles as well as track onto other surfaces such as driveways and sidewalks if driven through or walked upon while wet. If you do have oil on something, simple dish soap and water will clean the area if caught before the oil has had time to dry. Otherwise we recommend a citrus solvent-type cleaner.

Notification and no parking signs will be placed on the road a minimum of 3 days prior to the start of each phase of work. These signs will provide the roadwork dates when parking on the street will not be allowed. It is very important that our contractor's crews have access to the entire street. Please note that vehicles parked on the street blocking construction activities will be towed at the owners' expense. In order to sweep excess loose rocks after placement, we request that you park off the chip-sealed streets for two days following the placement of the chip seal.

In the event the contractor is unable to perform chip or slurry seal work on your street on the scheduled day project information signs at the entrance to your street will be updated to provide the new date and times for the work.

If you have any questions regarding these access restrictions, please contact me at (925) 299-3247.

Sincerely,
Matt Luttrupp, Associate Engineer City of Lafayette

Street	Pavement Repairs	Crack Seal	Chip Seal	Slurry Seal
El Nido Ranch Road Linda Vista Lane to City Limits				
Middle Road Crest Road to Crest Road				
Dolores Drive Via Roble to End				
Happy Valley Court Happy Valley to End				
Brown Avenue Deer Hill Road to 1048 Brown Avenue				
Second Street Moraga Boulevard to Mt Diablo Boulevard				
School Street Moraga Road to Topper Lane				
Topper Lane School Street to Saint Mary's Road				
Hamlin Road Moraga Road to Solana Drive				
Las Trampas Road Reliez Station Road to Schelling Avenue				
Richelle Court Reliez Station Road to End				
Old Tunnel Road Linda Vista Lane to City Limits				
Camino Diablo (Freeway Crossing) Camino Diablo to Old Tunnel Road				
Los Palos Drive Los Palos Circle to Glenside Drive				
Sommerset Place Huntleigh Drive to End				

APPENDIX F

PROJECT NOTIFICATION SIGNS



**CITY OF LAFAYETTE STREET
MAINTENANCE PROJECT**

PAVEMENT REPAIR

EXPECT TRAFFIC DELAYS

DATE: TUES, JUNE 11

HOURS: 8:00 AM – 5:00 PM

CONTRACTOR: XXXXXXXXXXXXXXXXXXXXXXXXXXXX

Note:

1. Notification signs shall be printed with a yellow background.
2. Signs shall be a minimum of 3 feet wide by 3 feet tall.



**CITY OF LAFAYETTE STREET
MAINTENANCE PROJECT**

CHIP SEAL

ROAD CLOSURE

DATE: TUES, JUNE 11

HOURS: 8:00 AM – 5:00 PM

CONTRACTOR: XXXXXXXXXXXXXXXXXXXXXXXXXXXX

Note:

1. Notification signs shall be printed with a yellow background.
2. Signs shall be a minimum of 3 feet wide by 3 feet tall.



**CITY OF LAFAYETTE STREET
MAINTENANCE PROJECT**

**SLURRY SEAL
ROAD CLOSURE**

DATE: TUES, JUNE 11

HOURS: 8:00 AM – 5:00 PM

CONTRACTOR: XXXXXXXXXXXXXXXXXXXXXXXXXXXX

Note:

1. Notification signs shall be printed with a yellow background.
2. Signs shall be a minimum of 3 feet wide by 3 feet tall.



UPDATE

CITY OF LAFAYETTE STREET MAINTENANCE PROJECT

CHIP SEAL

ROAD CLOSURE

DATE: TUES, JUNE 11

HOURS: 8:00 AM – 5:00 PM

CONTRACTOR: XXXXXXXXXXXXXXXXXXXXXXXXXXXX

Note:

1. Re-notification signs shall be printed with a orange background.
2. Signs shall be a minimum of 3 feet wide by 3 feet tall.